

OUTDOOR UNITS

1. SPECIFICATIONS	2 - 30
2. EXTERNAL DIMENSIONS	2 - 53
3. CENTER OF GRAVITY	2 - 69
4. ELECTRICAL WIRING DIAGRAMS	2 - 70
5. SOUND LEVELS	2 - 72
6. CAPACITY TABLES	2 - 81
6-1. Correction by temperature	2 - 81
6-2. Correction by total indoor.....	2 - 91
6-3. Correction by refrigerant piping length.....	2 - 102
6-4. Correction at frost and defrost	2 - 106
6-5. Operation temperature range	2 - 107
7. OPTIONAL PARTS.....	2 - 108
7-1. JOINT	2 - 108
7-2. HEADER.....	2 - 109
7-3. OUTDOOR TWINNING KIT.....	2 - 110

1. SPECIFICATIONS

DATA G8

Model			PUHY-P200JM-A(-BS)	PUHY-P250JM-A(-BS)	
Power source			3-phase 4-wire 380-400-415V 50/60Hz		
Cooling capacity (Nominal)	*1	kW	22.4	28.0	
	*1	kcal / h	19,300	24,100	
	*1	BTU / h	76,400	95,500	
		Power input	kW	5.62	7.40
		Current input	A	9.4-9.0-8.6	12.4-11.8-11.4
		COP	kW / kW	3.98	3.78
Temp. range of cooling	Indoor	W.B.	15.0~24.0°C(59~75°F)		
	Outdoor	D.B.	-5.0~46.0°C(23~115°F)		
Heating capacity (Nominal)	*2	kW	25.0	31.5	
	*2	kcal / h	21,500	27,100	
	*2	BTU / h	85,300	107,500	
		Power input	kW	5.84	7.34
		Current input	A	9.8-9.3-9.0	12.3-11.7-11.3
		COP	kW / kW	4.28	4.29
Temp. range of heating	Indoor	D.B.	15.0~27.0°C(59~81°F)		
	Outdoor	W.B.	-20.0~15.5°C(-4~60°F)		
Indoor unit connectable	Total capacity		50~130 % of outdoor unit capacity		
	Model / Quantity		P15~P250 / 1~17		
Sound pressure level (measured in anechoic room)		dB <A>	56	58	
Power pressure level (measured in anechoic room)		dB <A>	76	78	
Refrigerant piping diameter	Liquid pipe	mm (in.)	9.52(3/8) Brazed		
	Gas pipe	mm (in.)	19.05(3/4) Brazed		
FAN	Type x Quantity		Propeller fan x 1		
	Air flow rate	m ³ / min	170		
		L/s	2,833		
		cfm	6,003		
	Control, Driving mechanism		Inverter-control, Direct-driven by motor		
	Motor output	kW	0.46 x 1		
*3	External static press.		0 Pa (0 mmH ₂ O)		
Compressor	Type x Quantity		Inverter scroll hermetic compressor		
	Manufacture		AC&R Works, MITSUBISHI ELECTRIC CORPORATION		
	Starting method		Inverter		
	Motor output	kW	5.4		
	Case heater	kW	0.035		
	Lubricant		MEL32		
External finish			Pre-coated galvanized steel sheets (+powder coating for -BS type) <MUNSELL 5Y 8/1 or similar>		
External dimension HxWxD			1,710(1,650 without legs) x 920 x 760 67-3/8(65 without legs) x 36-1/4 x 29-15/16		
Protection devices	High pressure protection		High pressure sensor, High pressure switch at 4.15MPa (601 psi)		
	Inverter circuit (COMP. / FAN)		Over-heat protection, Over-current protection		
	Compressor		Over-heat protection		
	Fan motor		Thermal switch		
Refrigerant	Type x original charge		R410A x 6.5kg (15lbs)		
	Control		LEV and HIC circuit		
Net weight		kg (lbs)	190(419)	200(441)	
Heat exchanger			Salt-resistant cross fin & copper tube		
HIC circuit (HIC: Heat Inter-Changer)			Copper pipe,tube-in-tube structure		
Defrosting method			Auto-defrost mode (Reversed refrigerant cycle)		
Drawing	External		WKD94G062		
	Wiring		KE94C449		
Standard attachment	Document		Installation Manual		
	Accessory		Refrigerant conn. pipe		
Optional parts			Joint: CMY-Y102S-G2 Header: CMY-Y104/108/1010-G		
Remarks			Details on foundation work, duct work, insulation work, electrical wiring, power source switch, and other items shall be referred to the Installation Manual. Due to continuing improvement, above specifications may be subject to change without notice.		

Notes :	Unit converter
1.Nominal cooling conditions(subject to JIS B8615-1) Indoor:27°CDB/19°CWB(81°FDB/66°FWB), Outdoor:35°CDB(95°FDB) Pipe length:7.5m(24-9/16ft.), Level difference:0m(0ft.)	kcal =kW x 860 BTU/h =kW x 3,412
2.Nominal heating conditions(subject to JIS B8615-1) Indoor:20°CDB(68°FDB), Outdoor:7°CDB/6°CWB(45°FDB/43°FWB) Pipe length:7.5m(24-9/16ft.), Level difference:0m(0ft.)	cfm =m ³ /min x 35.31 lb =kg / 0.4536
3.External static pressure option is available (30Pa, 60Pa / 3.1mmH ₂ O, 6.1mmH ₂ O).	*Above specification data is subject to rounding variation.

1. SPECIFICATIONS

DATA G8

Model			PUHY-P300YJM-A(-BS)	PUHY-P350YJM-A(-BS)	
Power source			3-phase 4-wire 380-400-415V 50/60Hz		
Cooling capacity (Nominal)	*1	kW	33.5	40.0	
	*1	kcal / h	28,800	34,400	
	*1	BTU / h	114,300	136,500	
		Power input	kW	9.00	11.01
		Current input	A	15.1-14.4-13.9	18.5-17.6-17.0
		COP	kW / kW	3.72	3.63
Temp. range of cooling	Indoor	W.B.	15.0~24.0°C(59~75°F)		
	Outdoor	D.B.	-5.0~46.0°C(23~115°F)		
Heating capacity (Nominal)	*2	kW	37.5	45.0	
	*2	kcal / h	32,300	38,700	
	*2	BTU / h	128,000	153,500	
		Power input	kW	9.25	11.19
		Current input	A	15.6-14.8-14.2	18.8-17.9-17.2
		COP	kW / kW	4.05	4.02
Temp. range of heating	Indoor	D.B.	15.0~27.0°C(59~81°F)		
	Outdoor	W.B.	-20.0~15.5°C(-4~60°F)		
Indoor unit connectable	Total capacity	50~130 % of outdoor unit capacity		50~130 % of outdoor unit capacity	
	Model / Quantity	P15~P250 / 1~26		P15~P250 / 1~30	
Sound pressure level (measured in anechoic room)		dB <A>	59	60	
Power pressure level (measured in anechoic room)		dB <A>	79	80	
Refrigerant piping diameter	Liquid pipe	mm (in.)	9.52(3/8) Brazed (12.7(1/2) Brazed, total length >= 40m)		
	Gas pipe	mm (in.)	22.2(7/8) Brazed		
FAN	Type x Quantity		Propeller fan x 1		
	Air flow rate	m ³ / min	170	210	
		L/s	2,833	3,500	
		cfm	6,003	7,415	
	Control, Driving mechanism		Inverter-control, Direct-driven by motor		
Motor output	kW	0.46 x 1			
*3	External static press.		0 Pa (0 mmH ₂ O)		
Compressor	Type x Quantity		Inverter scroll hermetic compressor		
	Manufacture		AC&R Works, MITSUBISHI ELECTRIC CORPORATION		
	Starting method		Inverter		
	Motor output	kW	7.7		
	Case heater	kW	0.045		
	Lubricant		MEL32		
External finish			Pre-coated galvanized steel sheets (+powder coating for -BS type) <MUNSELL 5Y 8/1 or similar>		
External dimension HxWxD			mm 1,710(1,650 without legs) x 920 x 760 in. 67-3/8(65 without legs) x 36-1/4 x 29-15/16		
Protection devices	High pressure protection		High pressure sensor, High pressure switch at 4.15MPa (601 psi)		
	Inverter circuit (COMP. / FAN)		Over-heat protection, Over-current protection		
	Compressor		Over-heat protection		
	Fan motor		Thermal switch		
Refrigerant	Type x original charge		R410A x 8.0kg (18lbs)		
	Control		LEV and HIC circuit		
Net weight		kg (lbs)	215(474)	250(552)	
Heat exchanger			Salt-resistant cross fin & copper tube		
HIC circuit (HIC: Heat Inter-Changer)			Copper pipe, tube-in-tube structure		
Defrosting method			Auto-defrost mode (Reversed refrigerant cycle)		
Drawing	External		WKD94G062		
	Wiring		KE94C449		
Standard attachment	Document		Installation Manual		
	Accessory		Refrigerant conn. pipe		
Optional parts			Joint: CMY-Y102S/L-G2 Header: CMY-Y104/108/1010-G		
Remarks			Details on foundation work, duct work, insulation work, electrical wiring, power source switch, and other items shall be referred to the Installation Manual. Due to continuing improvement, above specifications may be subject to change without notice.		

Notes :	Unit converter
1.Nominal cooling conditions(subject to JIS B8615-1) Indoor:27°CDB/19°CWB(81°FDB/66°FWB), Outdoor:35°CDB(95°FDB) Pipe length:7.5m(24-9/16ft.), Level difference:0m(0ft.)	kcal =kW x 860
2.Nominal heating conditions(subject to JIS B8615-1) Indoor:20°CDB(68°FDB), Outdoor:7°CDB/6°CWB(45°FDB/43°FWB) Pipe length:7.5m(24-9/16ft.), Level difference:0m(0ft.)	BTU/h =kW x 3,412
3.External static pressure option is available (30Pa, 60Pa / 3.1mmH ₂ O, 6.1mmH ₂ O).	cfm =m ³ /min x 35.31
	lb =kg / 0.4536
	*Above specification data is subject to rounding variation.

1. SPECIFICATIONS

DATA G8

Model			PUHY-P400YJM-A(-BS)	PUHY-P450YJM-A(-BS)	
Power source			3-phase 4-wire 380-400-415V 50/60Hz		
Cooling capacity (Nominal)	*1	kW	45.0	50.0	
	*1	kcal / h	38,700	43,000	
	*1	BTU / h	153,500	170,600	
		Power input	kW	13.11	15.47
		Current input	A	22.1-21.0-20.2	26.1-24.8-23.9
		COP	kW / kW	3.43	3.23
Temp. range of cooling	Indoor	W.B.	15.0~24.0°C(59~75°F)		
	Outdoor	D.B.	-5.0~46.0°C(23~115°F)		
Heating capacity (Nominal)	*2	kW	50.0	56.0	
	*2	kcal / h	43,000	48,200	
	*2	BTU / h	170,600	191,100	
		Power input	kW	12.82	14.62
		Current input	A	21.6-20.5-19.8	24.6-23.4-22.5
		COP	kW / kW	3.90	3.83
Temp. range of heating	Indoor	D.B.	15.0~27.0°C(59~81°F)		
	Outdoor	W.B.	-20.0~15.5°C(-4~60°F)		
Indoor unit connectable	Total capacity		50~130 % of outdoor unit capacity		
	Model / Quantity		P15~P250 / 1~34		
Sound pressure level (measured in anechoic room)		dB <A>	61	62	
Power pressure level (measured in anechoic room)		dB <A>	81	82	
Refrigerant piping diameter	Liquid pipe	mm (in.)	12.7(1/2) Brazed	15.88(5/8) Brazed	
	Gas pipe	mm (in.)	28.58(1-1/8) Brazed	28.58(1-1/8) Brazed	
FAN	Type x Quantity		Propeller fan x 1		
	Air flow rate	m ³ / min	210	370	
		L/s	3,500	6,167	
		cfm	7,415	13,065	
	Control, Driving mechanism		Inverter-control, Direct-driven by motor		
	Motor output	kW	0.46 x 1	0.46 x 2	
*3	External static press.		0 Pa (0 mmH ₂ O)		
Compressor	Type x Quantity		Inverter scroll hermetic compressor		
	Manufacture		AC&R Works, MITSUBISHI ELECTRIC CORPORATION		
	Starting method		Inverter		
	Motor output	kW	10.1	11.6	
	Case heater	kW	0.045	0.045	
	Lubricant		MEL32		
External finish			Pre-coated galvanized steel sheets (+powder coating for -BS type) <MUNSELL 5Y 8/1 or similar>		
External dimension HxWxD			1,710(1,650 without legs) x 1,220 x 760 67-3/8(65 without legs) x 48-1/16 x 29-15/16		
Protection devices	High pressure protection		High pressure sensor, High pressure switch at 4.15MPa (601 psi)		
	Inverter circuit (COMP. / FAN)		Over-heat protection, Over-current protection		
	Compressor		Over-heat protection		
	Fan motor		Thermal switch		
Refrigerant	Type x original charge		R410A x 11.5kg (26lbs)		
	Control		LEV and HIC circuit		
Net weight		kg (lbs)	250(552)	290(640)	
Heat exchanger			Salt-resistant cross fin & copper tube		
HIC circuit (HIC: Heat Inter-Changer)			Copper pipe,tube-in-tube structure		
Defrosting method			Auto-defrost mode (Reversed refrigerant cycle)		
Drawing	External		WKD94G063	WKD94G064	
	Wiring		KE94C449	KE94C450	
Standard attachment	Document		Installation Manual	Installation Manual	
	Accessory		Refrigerant conn. pipe	Refrigerant conn. pipe	
Optional parts			Joint: CMY-Y102S/L-G2, CMY-Y202-G2 Header: CMY-Y104/108/1010-G		
Remarks			Details on foundation work, duct work, insulation work, electrical wiring, power source switch, and other items shall be referred to the Installation Manual. Due to continuing improvement, above specifications may be subject to change without notice.		

Notes :	Unit converter
1.Nominal cooling conditions(subject to JIS B8615-1) Indoor:27°CDB/19°CWB(81°FDB/66°FWB), Outdoor:35°CDB(95°FDB) Pipe length:7.5m(24-9/16ft.), Level difference:0m(0ft.)	kcal =kW x 860 BTU/h =kW x 3,412
2.Nominal heating conditions(subject to JIS B8615-1) Indoor:20°CDB(68°FDB), Outdoor:7°CDB/6°CWB(45°FDB/43°FWB) Pipe length:7.5m(24-9/16ft.), Level difference:0m(0ft.)	cfm =m ³ /min x 35.31 lb =kg / 0.4536
3.External static pressure option is available (30Pa, 60Pa / 3.1mmH ₂ O, 6.1mmH ₂ O).	*Above specification data is subject to rounding variation.

1. SPECIFICATIONS

Model			PUHY-P500YSJM-A(-BS)		
Power source			3-phase 4-wire 380-400-415V 50/60Hz		
Cooling capacity (Nominal)	*1	kW	56.0		
	*1	kcal / h	48,200		
	*1	BTU / h	191,100		
		Power input	kW	15.38	
		Current input	A	25.9-24.6-23.7	
	COP	kW / kW	3.64		
Temp. range of cooling	Indoor	W.B.	15.0~24.0°C(59~75°F)		
	Outdoor	D.B.	-5.0~46.0°C(23~115°F)		
Heating capacity (Nominal)	*2	kW	63.0		
	*2	kcal / h	54,200		
	*2	BTU / h	215,000		
		Power input	kW	15.03	
		Current input	A	25.3-24.1-23.2	
	COP	kW / kW	4.19		
Temp. range of heating	Indoor	D.B.	15.0~27.0°C(59~81°F)		
	Outdoor	W.B.	-20.0~15.5°C(-4~60°F)		
Indoor unit connectable	Total capacity		50~130 % of outdoor unit capacity		
	Model / Quantity		P15~P250 / 1~43		
Sound pressure level (measured in anechoic room)			dB <A>		
Power pressure level (measured in anechoic room)			dB <A>		
Refrigerant piping diameter	Liquid pipe	mm (in.)	15.88(5/8) Brazed		
	Gas pipe	mm (in.)	28.58(1-1/8) Brazed		

Set Model			PUHY-P250YJM-A(-BS)		PUHY-P250YJM-A(-BS)	
FAN	Type x Quantity		Propeller fan x 1		Propeller fan x 1	
	Air flow rate	m ³ / min	170		170	
		L/s	2,833		2,833	
		cfm	6,003		6,003	
	Control , Driving mechanism		Inverter-control, Direct-driven by motor		Inverter-control, Direct-driven by motor	
	*3	Motor output	kW	0.46 x 1		0.46 x 1
External static press.		0 Pa (0 mmH ₂ O)		0 Pa (0 mmH ₂ O)		
Compressor	Type x Quantity		Inverter scroll hermetic compressor		Inverter scroll hermetic compressor	
	Manufacture		AC&R Works, MITSUBISHI ELECTRIC CORPORATION		AC&R Works, MITSUBISHI ELECTRIC CORPORATION	
	Starting method		Inverter		Inverter	
	Motor output	kW	6.8		6.8	
	Case heater	kW	0.035		0.035	
	Lubricant		MEL32		MEL32	
External finish			Pre-coated galvanized steel sheets (+powder coating for -BS type) <MUNSELL 5Y 8/1 or similar>		Pre-coated galvanized steel sheets (+powder coating for -BS type) <MUNSELL 5Y 8/1 or similar>	
External dimension HxWxD			mm 1,710(1,650 without legs) x 920 x 760 67-3/8(65 without legs) x 36-1/4 x 29-15/16		mm 1,710(1,650 without legs) x 920 x 760 67-3/8(65 without legs) x 36-1/4 x 29-15/16	
Protection devices	High pressure protection		High pressure sensor, High pressure switch at 4.15MPa (601 psi)		High pressure sensor, High pressure switch at 4.15MPa (601 psi)	
	Inverter circuit (COMP. / FAN)		Over-heat protection, Over-current protection		Over-heat protection, Over-current protection	
	Compressor		Over-heat protection		Over-heat protection	
	Fan motor		Thermal switch		Thermal switch	
Refrigerant	Type x original charge		R410A x 8.0kg (18lbs)		R410A x 8.0kg (18lbs)	
	Control		LEV and HIC circuit		LEV and HIC circuit	
Net weight		kg (lbs)	200(441)		200(441)	
Heat exchanger			Salt-resistant cross fin & copper tube		Salt-resistant cross fin & copper tube	
HIC circuit (HIC: Heat Inter-Changer)			Copper pipe,tube-in-tube structure		Copper pipe,tube-in-tube structure	
Pipe between unit and distributor	Liquid pipe	mm (in.)	9.52(3/8) Brazed		9.52(3/8) Brazed	
	Gas pipe	mm (in.)	22.2(7/8) Brazed		22.2(7/8) Brazed	
Defrosting method			Auto-defrost mode (Reversed refrigerant cycle)		Auto-defrost mode (Reversed refrigerant cycle)	
Drawing	External		WKD94G065		WKD94G065	
	Wiring		KE94C449		KE94C449	
Standard attachment	Document		Installation Manual		Installation Manual	
	Accessory		Refrigerant conn. pipe		Refrigerant conn. pipe	
Optional parts			Outdoor Twinning kit: CMY-Y100VBK2 Joint: CMY-Y102S/L-G2,CMY-Y202-G2 Header: CMY-Y104/108/1010-G		Outdoor Twinning kit: CMY-Y100VBK2 Joint: CMY-Y102S/L-G2,CMY-Y202-G2 Header: CMY-Y104/108/1010-G	
Remarks			Details on foundation work, duct work, insulation work, electrical wiring, power source switch, and other items shall be referred to the Installation Manual. Due to continuing improvement, above specifications may be subject to change without notice.		Details on foundation work, duct work, insulation work, electrical wiring, power source switch, and other items shall be referred to the Installation Manual. Due to continuing improvement, above specifications may be subject to change without notice.	

Notes :	Unit converter
1.Nominal cooling conditions(subject to JIS B8615-1) Indoor:27°CDB/19°CWB(81°FDB/66°FWB), Outdoor:35°CDB(95°FDB) Pipe length:7.5m(24-9/16ft.), Level difference:0m(0ft.)	kcal =kW x 860 BTU/h =kW x 3,412
2.Nominal heating conditions(subject to JIS B8615-1) Indoor:20°CDB(68°FDB), Outdoor:7°CDB/6°CWB(45°FDB/43°FWB) Pipe length:7.5m(24-9/16ft.), Level difference:0m(0ft.)	cfm =m ³ /min x 35.31 lb =kg / 0.4536
3.External static pressure option is available (30Pa, 60Pa / 3.1mmH ₂ O, 6.1mmH ₂ O).	*Above specification data is subject to rounding variation.

1. SPECIFICATIONS

DATA G8

Model			PUHY-P500YSJM-A1(-BS)	
Power source			3-phase 4-wire 380-400-415V 50/60Hz	
Cooling capacity (Nominal)	*1	kW	56.0	
	*1	kcal / h	48,200	
	*1	BTU / h	191,100	
		Power input	kW	
		Current input	A	
		COP	kW / kW	
Temp. range of cooling	Indoor	W.B.	15.0~24.0°C(59~75°F)	
	Outdoor	D.B.	-5.0~46.0°C(23~115°F)	
Heating capacity (Nominal)	*2	kW	63.0	
	*2	kcal / h	54,200	
	*2	BTU / h	215,000	
		Power input	kW	
		Current input	A	
		COP	kW / kW	
Temp. range of heating	Indoor	D.B.	15.0~27.0°C(59~81°F)	
	Outdoor	W.B.	-20.0~15.5°C(-4~60°F)	
Indoor unit connectable	Total capacity	50~130 % of outdoor unit capacity		
	Model / Quantity	P15~P250 / 1~43		
Sound pressure level (measured in anechoic room)		dB <A>		61
Power pressure level (measured in anechoic room)		dB <A>		81
Refrigerant piping diameter	Liquid pipe	mm (in.)	15.88(5/8) Brazed	
	Gas pipe	mm (in.)	28.58(1-1/8) Brazed	

Set Model			PUHY-P200YJM-A(-BS)		PUHY-P300YJM-A(-BS)	
Model			Propeller fan x 1		Propeller fan x 1	
FAN	Type x Quantity		170		170	
	Air flow rate	m ³ / min	2,833		2,833	
		L/s	6,003		6,003	
		cfm				
	Control , Driving mechanism		Inverter-control, Direct-driven by motor		Inverter-control, Direct-driven by motor	
	Motor output	kW	0.46 x 1		0.46 x 1	
*3	External static press.		0 Pa (0 mmH ₂ O)		0 Pa (0 mmH ₂ O)	
Compressor			Inverter scroll hermetic compressor		Inverter scroll hermetic compressor	
Manufacture			AC&R Works, MITSUBISHI ELECTRIC CORPORATION		AC&R Works, MITSUBISHI ELECTRIC CORPORATION	
Starting method			Inverter		Inverter	
Motor output	kW	5.4		7.7		
Case heater	kW	0.035		0.045		
Lubricant			MEL32		MEL32	
External finish			Pre-coated galvanized steel sheets (+powder coating for -BS type) <MUNSELL 5Y 8/1 or similar>		Pre-coated galvanized steel sheets (+powder coating for -BS type) <MUNSELL 5Y 8/1 or similar>	
External dimension HxWxD			1,710(1,650 without legs) x 920 x 760 67-3/8(65 without legs) x 36-1/4 x 29-15/16		1,710(1,650 without legs) x 920 x 760 67-3/8(65 without legs) x 36-1/4 x 29-15/16	
Protection devices	High pressure protection		High pressure sensor, High pressure switch at 4.15MPa (601 psi)		High pressure sensor, High pressure switch at 4.15MPa (601 psi)	
	Inverter circuit (COMP. / FAN)		Over-heat protection, Over-current protection		Over-heat protection, Over-current protection	
	Compressor		Over-heat protection		Over-heat protection	
	Fan motor		Thermal switch		Thermal switch	
Refrigerant	Type x original charge		R410A x 6.5kg (15lbs)		R410A x 8.0kg (18lbs)	
	Control		LEV and HIC circuit			
Net weight		kg (lbs)	190(419)		215(474)	
Heat exchanger			Salt-resistant cross fin & copper tube		Salt-resistant cross fin & copper tube	
HIC circuit (HIC: Heat Inter-Changer)			Copper pipe,tube-in-tube structure		Copper pipe,tube-in-tube structure	
Pipe between unit and distributor	Liquid pipe	mm (in.)	9.52(3/8) Brazed		12.7(1/2) Brazed	
	Gas pipe	mm (in.)	19.05(3/4) Brazed		22.2(7/8) Brazed	
Defrosting method			Auto-defrost mode (Reversed refrigerant cycle)			
Drawing	External		WKD94G065			
	Wiring		KE94C449		KE94C449	
Standard attachment	Document		Installation Manual			
	Accessory		Refrigerant conn. pipe			
Optional parts			Outdoor Twinning kit: CMY-Y100VBK2 Joint: CMY-Y102S/L-G2,CMY-Y202-G2 Header: CMY-Y104/108/1010-G			
Remarks			Details on foundation work, duct work, insulation work, electrical wiring, power source switch, and other items shall be referred to the Installation Manual. Due to continuing improvement, above specifications may be subject to change without notice.			

Notes :	Unit converter
1.Nominal cooling conditions(subject to JIS B8615-1) Indoor:27°CDB/19°CWB(81°FDB/66°FWB), Outdoor:35°CDB(95°FDB) Pipe length:7.5m(24-9/16ft.), Level difference:0m(0ft.)	kcal =kW x 860 BTU/h =kW x 3,412
2.Nominal heating conditions(subject to JIS B8615-1) Indoor:20°CDB(68°FDB), Outdoor:7°CDB/6°CWB(45°FDB/43°FWB) Pipe length:7.5m(24-9/16ft.), Level difference:0m(0ft.)	cfm =m ³ /min x 35.31 lb =kg / 0.4536
3.External static pressure option is available (30Pa, 60Pa / 3.1mmH ₂ O, 6.1mmH ₂ O).	*Above specification data is subject to rounding variation.

1. SPECIFICATIONS

Model			PUHY-P550YSJM-A(-BS)		
Power source			3-phase 4-wire 380-400-415V 50/60Hz		
Cooling capacity (Nominal)	*1	kW	63.0		
	*1	kcal / h	54,200		
	*1	BTU / h	215,000		
		Power input	kW	17.16	
		Current input	A	28.9-27.5-26.5	
		COP	kW / kW		3.67
Temp. range of cooling	Indoor	W.B.	15.0~24.0°C(59~75°F)		
	Outdoor	D.B.	-5.0~46.0°C(23~115°F)		
Heating capacity (Nominal)	*2	kW	69.0		
	*2	kcal / h	59,300		
	*2	BTU / h	235,400		
		Power input	kW	16.87	
		Current input	A	28.4-27.0-26.0	
		COP	kW / kW		4.09
Temp. range of heating	Indoor	D.B.	15.0~27.0°C(59~81°F)		
	Outdoor	W.B.	-20.0~15.5°C(-4~60°F)		
Indoor unit connectable	Total capacity	50~130 % of outdoor unit capacity			
	Model / Quantity	P15~P250 / 1~47			
Sound pressure level (measured in anechoic room)		dB <A>	61.5		
Power pressure level (measured in anechoic room)		dB <A>	81.5		
Refrigerant piping diameter	Liquid pipe	mm (in.)	15.88(5/8) Brazed		
	Gas pipe	mm (in.)	28.58(1-1/8) Brazed		

Set Model			PUHY-P250YJM-A(-BS)		PUHY-P300YJM-A(-BS)	
Model			Propeller fan x 1		Propeller fan x 1	
FAN	Type x Quantity		170		170	
	Air flow rate	m ³ / min	2,833		2,833	
		L/s	6,003		6,003	
		cfm				
	Control , Driving mechanism		Inverter-control, Direct-driven by motor		Inverter-control, Direct-driven by motor	
*3	Motor output	kW	0.46 x 1		0.46 x 1	
External static press.		0 Pa (0 mmH ₂ O)		0 Pa (0 mmH ₂ O)		
Compressor	Type x Quantity		Inverter scroll hermetic compressor		Inverter scroll hermetic compressor	
	Manufacture		AC&R Works, MITSUBISHI ELECTRIC CORPORATION		AC&R Works, MITSUBISHI ELECTRIC CORPORATION	
	Starting method		Inverter		Inverter	
	Motor output	kW	6.8		7.7	
	Case heater	kW	0.035		0.045	
Lubricant		MEL32		MEL32		
External finish			Pre-coated galvanized steel sheets (+powder coating for -BS type) <MUNSELL 5Y 8/1 or similar>		Pre-coated galvanized steel sheets (+powder coating for -BS type) <MUNSELL 5Y 8/1 or similar>	
External dimension HxWxD			1,710(1,650 without legs) x 920 x 760 67-3/8(65 without legs) x 36-1/4 x 29-15/16		1,710(1,650 without legs) x 920 x 760 67-3/8(65 without legs) x 36-1/4 x 29-15/16	
Protection devices	High pressure protection		High pressure sensor, High pressure switch at 4.15MPa (601 psi)		High pressure sensor, High pressure switch at 4.15MPa (601 psi)	
	Inverter circuit (COMP. / FAN)		Over-heat protection, Over-current protection		Over-heat protection, Over-current protection	
	Compressor		Over-heat protection		Over-heat protection	
	Fan motor		Thermal switch		Thermal switch	
Refrigerant	Type x original charge		R410A x 8.0kg (18lbs)		R410A x 8.0kg (18lbs)	
	Control		LEV and HIC circuit			
Net weight		kg (lbs)	200(441)		215(474)	
Heat exchanger			Salt-resistant cross fin & copper tube		Salt-resistant cross fin & copper tube	
HIC circuit (HIC: Heat Inter-Changer)			Copper pipe,tube-in-tube structure		Copper pipe,tube-in-tube structure	
Pipe between unit and distributor	Liquid pipe	mm (in.)	9.52(3/8) Brazed		12.7(1/2) Brazed	
	Gas pipe	mm (in.)	22.2(7/8) Brazed		22.2(7/8) Brazed	
Defrosting method			Auto-defrost mode (Reversed refrigerant cycle)			
Drawing	External		WKD94G065			
	Wiring		KE94C449		KE94C449	
Standard attachment	Document		Installation Manual			
	Accessory		Refrigerant conn. pipe			
Optional parts			Outdoor Twinning kit: CMY-Y100VBK2 Joint: CMY-Y102S/L-G2, CMY-Y202/302-G2 Header: CMY-Y104/108/1010-G			
Remarks			Details on foundation work, duct work, insulation work, electrical wiring, power source switch, and other items shall be referred to the Installation Manual. Due to continuing improvement, above specifications may be subject to change without notice.			

Notes :	Unit converter
1.Nominal cooling conditions(subject to JIS B8615-1) Indoor:27°CDB/19°CWB(81°FDB/66°FWB), Outdoor:35°CDB(95°FDB) Pipe length:7.5m(24-9/16ft.), Level difference:0m(0ft.)	kcal =kW x 860
2.Nominal heating conditions(subject to JIS B8615-1) Indoor:20°CDB(68°FDB), Outdoor:7°CDB/6°CWB(45°FDB/43°FWB) Pipe length:7.5m(24-9/16ft.), Level difference:0m(0ft.)	BTU/h =kW x 3,412
3.External static pressure option is available (30Pa, 60Pa / 3.1mmH ₂ O, 6.1mmH ₂ O).	cfm =m ³ /min x 35.31
	lb =kg / 0.4536
	*Above specification data is subject to rounding variation.

1. SPECIFICATIONS

DATA G8

Model			PUHY-P600YSJM-A(-BS)		
Power source			3-phase 4-wire 380-400-415V 50/60Hz		
Cooling capacity (Nominal)	*1	kW	69.0		
	*1	kcal / h	59,300		
	*1	BTU / h	235,400		
		Power input	kW	18.75	
		Current input	A	31.6-30.0-28.9	
		COP	kW / kW		3.68
Temp. range of cooling	Indoor	W.B.	15.0~24.0°C(59~75°F)		
	Outdoor	D.B.	-5.0~46.0°C(23~115°F)		
Heating capacity (Nominal)	*2	kW	76.5		
	*2	kcal / h	65,800		
	*2	BTU / h	261,000		
		Power input	kW	18.88	
		Current input	A	31.8-30.2-29.1	
		COP	kW / kW		4.05
Temp. range of heating	Indoor	D.B.	15.0~27.0°C(59~81°F)		
	Outdoor	W.B.	-20.0~15.5°C(-4~60°F)		
Indoor unit connectable	Total capacity	50~130 % of outdoor unit capacity			
	Model / Quantity	P15~P250 / 1~50			
Sound pressure level (measured in anechoic room)	dB <A>		62		
Power pressure level (measured in anechoic room)	dB <A>		82		
Refrigerant piping diameter	Liquid pipe	mm (in.)	15.88(5/8) Brazed		
	Gas pipe	mm (in.)	28.58(1-1/8) Brazed		

Set Model			PUHY-P250YJM-A(-BS)		PUHY-P350YJM-A(-BS)			
Model			Propeller fan x 1		Propeller fan x 1			
FAN	Type x Quantity		170		210			
	Air flow rate	m ³ / min	2,833		3,500			
		L/s	6,003		7,415			
		cfm						
	Control , Driving mechanism		Inverter-control, Direct-driven by motor		Inverter-control, Direct-driven by motor			
Motor output	kW	0.46 x 1		0.46 x 1				
*3	External static press.		0 Pa (0 mmH ₂ O)		0 Pa (0 mmH ₂ O)			
Compressor	Type x Quantity		Inverter scroll hermetic compressor		Inverter scroll hermetic compressor			
	Manufacture		AC&R Works, MITSUBISHI ELECTRIC CORPORATION		AC&R Works, MITSUBISHI ELECTRIC CORPORATION			
	Starting method		Inverter		Inverter			
	Motor output	kW	6.8		9.9			
	Case heater	kW	0.035		0.045			
Lubricant		MEL32		MEL32				
External finish			Pre-coated galvanized steel sheets (+powder coating for -BS type) <MUNSELL 5Y 8/1 or similar>		Pre-coated galvanized steel sheets (+powder coating for -BS type) <MUNSELL 5Y 8/1 or similar>			
External dimension HxWxD			1,710(1,650 without legs) x 920 x 760 67-3/8(65 without legs) x 36-1/4 x 29-15/16		1,710(1,650 without legs) x 1,220 x 760 67-3/8(65 without legs) x 48-1/16 x 29-15/16			
Protection devices	High pressure protection		High pressure sensor, High pressure switch at 4.15MPa (601 psi)		High pressure sensor, High pressure switch at 4.15MPa (601 psi)			
	Inverter circuit (COMP. / FAN)		Over-heat protection, Over-current protection		Over-heat protection, Over-current protection			
	Compressor		Over-heat protection		Over-heat protection			
	Fan motor		Thermal switch		Thermal switch			
Refrigerant	Type x original charge		R410A x 8.0kg (18lbs)		R410A x 11.5kg (26lbs)			
	Control		LEV and HIC circuit					
Net weight			kg (lbs)		200(441)		250(552)	
Heat exchanger			Salt-resistant cross fin & copper tube		Salt-resistant cross fin & copper tube			
HIC circuit (HIC: Heat Inter-Changer)			Copper pipe,tube-in-tube structure		Copper pipe,tube-in-tube structure			
Pipe between unit and distributor	Liquid pipe	mm (in.)	9.52(3/8) Brazed		12.7(1/2) Brazed			
	Gas pipe	mm (in.)	22.2(7/8) Brazed		28.58(1-1/8) Brazed			
Defrosting method			Auto-defrost mode (Reversed refrigerant cycle)					
Drawing	External		WKD94G066					
	Wiring		KE94C449			KE94C449		
Standard attachment	Document		Installation Manual					
	Accessory		Refrigerant conn. pipe					
Optional parts			Outdoor Twinning kit: CMY-Y100VBK2 Joint: CMY-Y102S/L-G2, CMY-Y202/302-G2 Header: CMY-Y104/108/1010-G					
Remarks			Details on foundation work, duct work, insulation work, electrical wiring, power source switch, and other items shall be referred to the Installation Manual. Due to continuing improvement, above specifications may be subject to change without notice.					

Notes :		Unit converter	
1.Nominal cooling conditions(subject to JIS B8615-1) Indoor:27°CDB/19°CWB(81°FDB/66°FWB), Outdoor:35°CDB(95°FDB) Pipe length:7.5m(24-9/16ft.), Level difference:0m(0ft.)		kcal	=kW x 860
2.Nominal heating conditions(subject to JIS B8615-1) Indoor:20°CDB(68°FDB), Outdoor:7°CDB/6°CWB(45°FDB/43°FWB) Pipe length:7.5m(24-9/16ft.), Level difference:0m(0ft.)		BTU/h	=kW x 3,412
3.External static pressure option is available (30Pa, 60Pa / 3.1mmH ₂ O, 6.1mmH ₂ O).		cfm	=m ³ /min x 35.31
		lb	=kg / 0.4536
*Above specification data is subject to rounding variation.			

1. SPECIFICATIONS

Model			PUHY-P600YSJM-A1(-BS)		
Power source			3-phase 4-wire 380-400-415V 50/60Hz		
Cooling capacity (Nominal)	*1	kW	69.0		
	*1	kcal / h	59,300		
	*1	BTU / h	235,400		
		Power input	kW	19.00	
		Current input	A	32.0-30.4-29.3	
		COP	kW / kW	3.63	
Temp. range of cooling	Indoor	W.B.	15.0~24.0°C(59~75°F)		
	Outdoor	D.B.	-5.0~46.0°C(23~115°F)		
Heating capacity (Nominal)	*2	kW	76.5		
	*2	kcal / h	65,800		
	*2	BTU / h	261,000		
		Power input	kW	19.26	
		Current input	A	32.5-30.8-29.7	
		COP	kW / kW	3.97	
Temp. range of heating	Indoor	D.B.	15.0~27.0°C(59~81°F)		
	Outdoor	W.B.	-20.0~15.5°C(-4~60°F)		
Indoor unit connectable	Total capacity	50~130 % of outdoor unit capacity			
	Model / Quantity	P15~P250 / 1~50			
Sound pressure level (measured in anechoic room)		dB <A>	62		
Power pressure level (measured in anechoic room)		dB <A>	82		
Refrigerant piping diameter	Liquid pipe	mm (in.)	15.88(5/8) Brazed		
	Gas pipe	mm (in.)	28.58(1-1/8) Brazed		

Set Model			PUHY-P300YJM-A(-BS)		PUHY-P300YJM-A(-BS)	
Model			Propeller fan x 1		Propeller fan x 1	
FAN	Type x Quantity		170		170	
	Air flow rate	m ³ / min	2,833		2,833	
		L/s	6,003		6,003	
		cfm				
	Control , Driving mechanism		Inverter-control, Direct-driven by motor		Inverter-control, Direct-driven by motor	
	Motor output	kW	0.46 x 1		0.46 x 1	
*3	External static press.		0 Pa (0 mmH ₂ O)		0 Pa (0 mmH ₂ O)	
Compressor	Type x Quantity		Inverter scroll hermetic compressor		Inverter scroll hermetic compressor	
	Manufacture		AC&R Works, MITSUBISHI ELECTRIC CORPORATION		AC&R Works, MITSUBISHI ELECTRIC CORPORATION	
	Starting method		Inverter		Inverter	
	Motor output	kW	7.7		7.7	
	Case heater	kW	0.045		0.045	
	Lubricant		MEL32		MEL32	
External finish			Pre-coated galvanized steel sheets (+powder coating for -BS type) <MUNSELL 5Y 8/1 or similar>		Pre-coated galvanized steel sheets (+powder coating for -BS type) <MUNSELL 5Y 8/1 or similar>	
External dimension HxWxD			1,710(1,650 without legs) x 920 x 760 67-3/8(65 without legs) x 36-1/4 x 29-15/16		1,710(1,650 without legs) x 920 x 760 67-3/8(65 without legs) x 36-1/4 x 29-15/16	
Protection devices	High pressure protection		High pressure sensor, High pressure switch at 4.15MPa (601 psi)		High pressure sensor, High pressure switch at 4.15MPa (601 psi)	
	Inverter circuit (COMP. / FAN)		Over-heat protection, Over-current protection		Over-heat protection, Over-current protection	
	Compressor		Over-heat protection		Over-heat protection	
	Fan motor		Thermal switch		Thermal switch	
Refrigerant	Type x original charge		R410A x 8.0kg (18lbs)		R410A x 8.0kg (18lbs)	
	Control		LEV and HIC circuit			
Net weight	kg (lbs)		215(474)		215(474)	
Heat exchanger			Salt-resistant cross fin & copper tube		Salt-resistant cross fin & copper tube	
HIC circuit (HIC: Heat Inter-Changer)			Copper pipe,tube-in-tube structure		Copper pipe,tube-in-tube structure	
Pipe between unit and distributor	Liquid pipe	mm (in.)	12.7(1/2) Brazed		12.7(1/2) Brazed	
	Gas pipe	mm (in.)	22.2(7/8) Brazed		22.2(7/8) Brazed	
Defrosting method			Auto-defrost mode (Reversed refrigerant cycle)			
Drawing	External		WKD94G065			
	Wiring		KE94C449		KE94C449	
Standard attachment	Document		Installation Manual			
	Accessory		Refrigerant conn. pipe			
Optional parts			Outdoor Twinning kit: CMY-Y100VBK2 Joint: CMY-Y102S/L-G2, CMY-Y202/302-G2 Header: CMY-Y104/108/1010-G			
Remarks			Details on foundation work, duct work, insulation work, electrical wiring, power source switch, and other items shall be referred to the Installation Manual. Due to continuing improvement, above specifications may be subject to change without notice.			

Notes :	Unit converter
1.Nominal cooling conditions(subject to JIS B8615-1) Indoor:27°CDB/19°CWB(81°FDB/66°FWB), Outdoor:35°CDB(95°FDB) Pipe length:7.5m(24-9/16ft.), Level difference:0m(0ft.)	kcal =kW x 860
2.Nominal heating conditions(subject to JIS B8615-1) Indoor:20°CDB(68°FDB), Outdoor:7°CDB/6°CWB(45°FDB/43°FWB) Pipe length:7.5m(24-9/16ft.), Level difference:0m(0ft.)	BTU/h =kW x 3,412
3.External static pressure option is available (30Pa, 60Pa / 3.1mmH ₂ O, 6.1mmH ₂ O).	cfm =m ³ /min x 35.31
	lb =kg / 0.4536
	*Above specification data is subject to rounding variation.

1. SPECIFICATIONS

DATA G8

Model			PUHY-P650YSJM-A(-BS)			
Power source			3-phase 4-wire 380-400-415V 50/60Hz			
Cooling capacity (Nominal)	*1	kW	73.0			
	*1	kcal / h	62,800			
	*1	BTU / h	249,100			
	Power input		kW	20.39		
	Current input		A	34.4-32.7-31.5		
COP		kW / kW	3.58			
Temp. range of cooling	Indoor	W.B.	15.0~24.0°C(59~75°F)			
	Outdoor	D.B.	-5.0~46.0°C(23~115°F)			
Heating capacity (Nominal)	*2	kW	81.5			
	*2	kcal / h	70,100			
	*2	BTU / h	278,100			
	Power input		kW	20.47		
	Current input		A	34.5-32.8-31.6		
COP		kW / kW	3.98			
Temp. range of heating	Indoor	D.B.	15.0~27.0°C(59~81°F)			
	Outdoor	W.B.	-20.0~15.5°C(-4~60°F)			
Indoor unit connectable	Total capacity		50~130 % of outdoor unit capacity			
	Model / Quantity		P15~P250 / 1~50			
Sound pressure level (measured in anechoic room)		dB <A>	62.5			
Power pressure level (measured in anechoic room)		dB <A>	82.5			
Refrigerant piping diameter	Liquid pipe	mm (in.)	15.88(5/8) Brazed			
	Gas pipe	mm (in.)	28.58(1-1/8) Brazed			

Set Model			PUHY-P300YJM-A(-BS)			PUHY-P350YJM-A(-BS)		
FAN	Type x Quantity		Propeller fan x 1			Propeller fan x 1		
	Air flow rate	m ³ / min	170			210		
		L/s	2,833			3,500		
		cfm	6,003			7,415		
	Control , Driving mechanism		Inverter-control, Direct-driven by motor			Inverter-control, Direct-driven by motor		
	Motor output	kW	0.46 x 1			0.46 x 1		
*3	External static press.		0 Pa (0 mmH ₂ O)			0 Pa (0 mmH ₂ O)		
Compressor	Type x Quantity		Inverter scroll hermetic compressor			Inverter scroll hermetic compressor		
	Manufacture		AC&R Works, MITSUBISHI ELECTRIC CORPORATION			AC&R Works, MITSUBISHI ELECTRIC CORPORATION		
	Starting method		Inverter			Inverter		
	Motor output	kW	7.7			9.9		
	Case heater	kW	0.045			0.045		
	Lubricant		MEL32			MEL32		
External finish		Pre-coated galvanized steel sheets (+powder coating for -BS type) <MUNSELL 5Y 8/1 or similar>			Pre-coated galvanized steel sheets (+powder coating for -BS type) <MUNSELL 5Y 8/1 or similar>			
External dimension HxWxD		mm	1,710(1,650 without legs) x 920 x 760			1,710(1,650 without legs) x 1,220 x 760		
		in.	67-3/8(65 without legs) x 36-1/4 x 29-15/16			67-3/8(65 without legs) x 48-1/16 x 29-15/16		
Protection devices	High pressure protection		High pressure sensor, High pressure switch at 4.15MPa (601 psi)			High pressure sensor, High pressure switch at 4.15MPa (601 psi)		
	Inverter circuit (COMP. / FAN)		Over-heat protection, Over-current protection			Over-heat protection, Over-current protection		
	Compressor		Over-heat protection			Over-heat protection		
	Fan motor		Thermal switch			Thermal switch		
Refrigerant	Type x original charge		R410A x 8.0kg (18lbs)			R410A x 11.5kg (26lbs)		
	Control		LEV and HIC circuit					
Net weight		kg (lbs)	215(474)			250(552)		
Heat exchanger		Salt-resistant cross fin & copper tube			Salt-resistant cross fin & copper tube			
HIC circuit (HIC: Heat Inter-Changer)		Copper pipe,tube-in-tube structure			Copper pipe,tube-in-tube structure			
Pipe between unit and distributor	Liquid pipe	mm (in.)	12.7(1/2) Brazed			12.7(1/2) Brazed		
	Gas pipe	mm (in.)	22.2(7/8) Brazed			28.58(1-1/8) Brazed		
Defrosting method		Auto-defrost mode (Reversed refrigerant cycle)						
Drawing	External		WKD94G066					
	Wiring		KE94C449			KE94C449		
Standard attachment	Document		Installation Manual					
	Accessory		Refrigerant conn. pipe					
Optional parts		Outdoor Twinning kit: CMY-Y100VBK2 Joint: CMY-Y102S/L-G2, CMY-Y202/302-G2 Header: CMY-Y104/108/1010-G						
Remarks		Details on foundation work, duct work, insulation work, electrical wiring, power source switch, and other items shall be referred to the Installation Manual. Due to continuing improvement, above specifications may be subject to change without notice.						

Notes :		Unit converter	
1.Nominal cooling conditions(subject to JIS B8615-1) Indoor:27°CDB/19°CWB(81°FDB/66°FWB), Outdoor:35°CDB(95°FDB) Pipe length:7.5m(24-9/16ft.), Level difference:0m(0ft.)		kcal	=kW x 860
2.Nominal heating conditions(subject to JIS B8615-1) Indoor:20°CDB(68°FDB), Outdoor:7°CDB/6°CWB(45°FDB/43°FWB) Pipe length:7.5m(24-9/16ft.), Level difference:0m(0ft.)		BTU/h	=kW x 3,412
3.External static pressure option is available (30Pa, 60Pa / 3.1mmH ₂ O, 6.1mmH ₂ O).		cfm	=m ³ /min x 35.31
		lb	=kg / 0.4536
		*Above specification data is subject to rounding variation.	

1. SPECIFICATIONS

Model			PUHY-P700YSJM-A(-BS)		
Power source			3-phase 4-wire 380-400-415V 50/60Hz		
Cooling capacity (Nominal)	*1	kW	80.0		
	*1	kcal / h	68,800		
	*1	BTU / h	273,000		
		Power input	kW	22.47	
		Current input	A	37.9-36.0-34.7	
		COP	kW / kW		3.56
Temp. range of cooling	Indoor	W.B.	15.0~24.0°C(59~75°F)		
	Outdoor	D.B.	-5.0~46.0°C(23~115°F)		
Heating capacity (Nominal)	*2	kW	88.0		
	*2	kcal / h	75,700		
	*2	BTU / h	300,300		
		Power input	kW	22.27	
		Current input	A	37.5-35.7-34.4	
		COP	kW / kW		3.95
Temp. range of heating	Indoor	D.B.	15.0~27.0°C(59~81°F)		
	Outdoor	W.B.	-20.0~15.5°C(-4~60°F)		
Indoor unit connectable	Total capacity	50~130 % of outdoor unit capacity			
	Model / Quantity	P15~P250 / 1~50			
Sound pressure level (measured in anechoic room)		dB <A>	63		
Power pressure level (measured in anechoic room)		dB <A>	83		
Refrigerant piping diameter	Liquid pipe	mm (in.)	19.05(3/4) Brazed		
	Gas pipe	mm (in.)	34.93(1-3/8) Brazed		

Set Model			PUHY-P350YJM-A(-BS)		PUHY-P350YJM-A(-BS)	
Model			Propeller fan x 1		Propeller fan x 1	
FAN	Type x Quantity		210		210	
	Air flow rate	m ³ / min	3,500		3,500	
		L/s	7,415		7,415	
		cfm				
	Control , Driving mechanism		Inverter-control, Direct-driven by motor		Inverter-control, Direct-driven by motor	
*3	Motor output	kW	0.46 x 1		0.46 x 1	
External static press.		0 Pa (0 mmH ₂ O)		0 Pa (0 mmH ₂ O)		
Compressor			Inverter scroll hermetic compressor		Inverter scroll hermetic compressor	
Manufacture			AC&R Works, MITSUBISHI ELECTRIC CORPORATION		AC&R Works, MITSUBISHI ELECTRIC CORPORATION	
Starting method			Inverter		Inverter	
Motor output		kW	9.9		9.9	
Case heater		kW	0.045		0.045	
Lubricant			MEL32		MEL32	
External finish			Pre-coated galvanized steel sheets (+powder coating for -BS type) <MUNSELL 5Y 8/1 or similar>		Pre-coated galvanized steel sheets (+powder coating for -BS type) <MUNSELL 5Y 8/1 or similar>	
External dimension HxWxD		mm	1,710(1,650 without legs) x 1,220 x 760		1,710(1,650 without legs) x 1,220 x 760	
		in.	67-3/8(65 without legs) x 48-1/16 x 29-15/16		67-3/8(65 without legs) x 48-1/16 x 29-15/16	
Protection devices	High pressure protection		High pressure sensor, High pressure switch at 4.15MPa (601 psi)		High pressure sensor, High pressure switch at 4.15MPa (601 psi)	
	Inverter circuit (COMP. / FAN)		Over-heat protection, Over-current protection		Over-heat protection, Over-current protection	
	Compressor		Over-heat protection		Over-heat protection	
	Fan motor		Thermal switch		Thermal switch	
Refrigerant	Type x original charge		R410A x 11.5kg (26lbs)		R410A x 11.5kg (26lbs)	
	Control		LEV and HIC circuit			
Net weight		kg (lbs)	250(552)		250(552)	
Heat exchanger			Salt-resistant cross fin & copper tube		Salt-resistant cross fin & copper tube	
HIC circuit (HIC: Heat Inter-Changer)			Copper pipe,tube-in-tube structure		Copper pipe,tube-in-tube structure	
Pipe between unit and distributor	Liquid pipe	mm (in.)	12.7(1/2) Brazed		12.7(1/2) Brazed	
	Gas pipe	mm (in.)	28.58(1-1/8) Brazed		28.58(1-1/8) Brazed	
Defrosting method			Auto-defrost mode (Reversed refrigerant cycle)			
Drawing	External		WKD94G067			
	Wiring		KE94C449		KE94C449	
Standard attachment	Document		Installation Manual			
	Accessory		Refrigerant conn. pipe			
Optional parts			Outdoor Twinning kit: CMY-Y200VBK2 Joint: CMY-Y102S/L-G2, CMY-Y202/302-G2 Header: CMY-Y104/108/1010-G			
Remarks			Details on foundation work, duct work, insulation work, electrical wiring, power source switch, and other items shall be referred to the Installation Manual. Due to continuing improvement, above specifications may be subject to change without notice.			

Notes :	Unit converter
1.Nominal cooling conditions(subject to JIS B8615-1) Indoor:27°CDB/19°CWB(81°FDB/66°FWB), Outdoor:35°CDB(95°FDB) Pipe length:7.5m(24-9/16ft.), Level difference:0m(0ft.)	kcal =kW x 860
2.Nominal heating conditions(subject to JIS B8615-1) Indoor:20°CDB(68°FDB), Outdoor:7°CDB/6°CWB(45°FDB/43°FWB) Pipe length:7.5m(24-9/16ft.), Level difference:0m(0ft.)	BTU/h =kW x 3,412
3.External static pressure option is available (30Pa, 60Pa / 3.1mmH ₂ O, 6.1mmH ₂ O).	cfm =m ³ /min x 35.31
	lb =kg / 0.4536
	*Above specification data is subject to rounding variation.

1. SPECIFICATIONS

Model			PUHY-P700YSJM-A1(-BS)		
Power source			3-phase 4-wire 380-400-415V 50/60Hz		
Cooling capacity (Nominal)	*1	kW	80.0		
	*1	kcal / h	68,800		
	*1	BTU / h	273,000		
		Power input	kW	23.05	
		Current input	A	38.9-36.9-35.6	
		COP	kW / kW		3.47
Temp. range of cooling	Indoor	W.B.	15.0~24.0°C(59~75°F)		
	Outdoor	D.B.	-5.0~46.0°C(23~115°F)		
Heating capacity (Nominal)	*2	kW	88.0		
	*2	kcal / h	75,700		
	*2	BTU / h	300,300		
		Power input	kW	23.09	
		Current input	A	38.9-37.0-35.6	
		COP	kW / kW		3.81
Temp. range of heating	Indoor	D.B.	15.0~27.0°C(59~81°F)		
	Outdoor	W.B.	-20.0~15.5°C(-4~60°F)		
Indoor unit connectable	Total capacity	50~130 % of outdoor unit capacity			
	Model / Quantity	P15~P250 / 1~50			
Sound pressure level (measured in anechoic room)	dB <A>		63		
Power pressure level (measured in anechoic room)	dB <A>		83		
Refrigerant piping diameter	Liquid pipe	mm (in.)	19.05(3/4) Brazed		
	Gas pipe	mm (in.)	34.93(1-3/8) Brazed		

Set Model			PUHY-P300YJM-A(-BS)		PUHY-P400YJM-A(-BS)	
Model			Propeller fan x 1		Propeller fan x 1	
FAN	Type x Quantity		170		210	
	Air flow rate	m ³ / min	2,833		3,500	
		L/s	6,003		7,415	
		cfm				
	Control , Driving mechanism		Inverter-control, Direct-driven by motor		Inverter-control, Direct-driven by motor	
Motor output	kW	0.46 x 1		0.46 x 1		
*3	External static press.		0 Pa (0 mmH ₂ O)		0 Pa (0 mmH ₂ O)	
Compressor	Type x Quantity		Inverter scroll hermetic compressor		Inverter scroll hermetic compressor	
	Manufacture		AC&R Works, MITSUBISHI ELECTRIC CORPORATION		AC&R Works, MITSUBISHI ELECTRIC CORPORATION	
	Starting method		Inverter		Inverter	
	Motor output	kW	7.7		10.1	
	Case heater	kW	0.045		0.045	
Lubricant		MEL32		MEL32		
External finish			Pre-coated galvanized steel sheets (+powder coating for -BS type) <MUNSELL 5Y 8/1 or similar>		Pre-coated galvanized steel sheets (+powder coating for -BS type) <MUNSELL 5Y 8/1 or similar>	
External dimension HxWxD			1,710(1,650 without legs) x 920 x 760 67-3/8(65 without legs) x 36-1/4 x 29-15/16		1,710(1,650 without legs) x 1,220 x 760 67-3/8(65 without legs) x 48-1/16 x 29-15/16	
Protection devices	High pressure protection		High pressure sensor, High pressure switch at 4.15MPa (601 psi)		High pressure sensor, High pressure switch at 4.15MPa (601 psi)	
	Inverter circuit (COMP. / FAN)		Over-heat protection, Over-current protection		Over-heat protection, Over-current protection	
	Compressor		Over-heat protection		Over-heat protection	
	Fan motor		Thermal switch		Thermal switch	
Refrigerant	Type x original charge		R410A x 8.0kg (18lbs)		R410A x 11.5kg (26lbs)	
	Control		LEV and HIC circuit			
Net weight		kg (lbs)	215(474)		250(552)	
Heat exchanger			Salt-resistant cross fin & copper tube		Salt-resistant cross fin & copper tube	
HIC circuit (HIC: Heat Inter-Changer)			Copper pipe,tube-in-tube structure		Copper pipe,tube-in-tube structure	
Pipe between unit and distributor	Liquid pipe	mm (in.)	12.7(1/2) Brazed		15.88(5/8) Brazed	
	Gas pipe	mm (in.)	22.2(7/8) Brazed		28.58(1-1/8) Brazed	
Defrosting method			Auto-defrost mode (Reversed refrigerant cycle)			
Drawing	External		WKD94G066			
	Wiring		KE94C449		KE94C449	
Standard attachment	Document		Installation Manual			
	Accessory		Refrigerant conn. pipe			
Optional parts			Outdoor Twinning kit: CMY-Y200VBK2 Joint: CMY-Y102S/L-G2, CMY-Y202/302-G2 Header: CMY-Y104/108/1010-G			
Remarks			Details on foundation work, duct work, insulation work, electrical wiring, power source switch, and other items shall be referred to the Installation Manual. Due to continuing improvement, above specifications may be subject to change without notice.			

Notes :	Unit converter
1.Nominal cooling conditions(subject to JIS B8615-1) Indoor:27°CDB/19°CWB(81°FDB/66°FWB), Outdoor:35°CDB(95°FDB) Pipe length:7.5m(24-9/16ft.), Level difference:0m(0ft.)	kcal =kW x 860
2.Nominal heating conditions(subject to JIS B8615-1) Indoor:20°CDB(68°FDB), Outdoor:7°CDB/6°CWB(45°FDB/43°FWB) Pipe length:7.5m(24-9/16ft.), Level difference:0m(0ft.)	BTU/h =kW x 3,412
3.External static pressure option is available (30Pa, 60Pa / 3.1mmH ₂ O, 6.1mmH ₂ O).	cfm =m ³ /min x 35.31
	lb =kg / 0.4536
	*Above specification data is subject to rounding variation.

1. SPECIFICATIONS

Model			PUHY-P750YSJM-A(-BS)		
Power source			3-phase 4-wire 380-400-415V 50/60Hz		
Cooling capacity (Nominal)	*1	kW	85.0		
	*1	kcal / h	73,100		
	*1	BTU / h	290,000		
		Power input	kW	24.70	
		Current input	A	41.6-39.6-38.1	
		COP	kW / kW		3.44
Temp. range of cooling	Indoor	W.B.	15.0~24.0°C(59~75°F)		
	Outdoor	D.B.	-5.0~46.0°C(23~115°F)		
Heating capacity (Nominal)	*2	kW	95.0		
	*2	kcal / h	81,700		
	*2	BTU / h	324,100		
		Power input	kW	24.67	
		Current input	A	41.6-39.5-38.1	
		COP	kW / kW		3.85
Temp. range of heating	Indoor	D.B.	15.0~27.0°C(59~81°F)		
	Outdoor	W.B.	-20.0~15.5°C(-4~60°F)		
Indoor unit connectable	Total capacity	50~130 % of outdoor unit capacity			
	Model / Quantity	P15~P250 / 1~50			
Sound pressure level (measured in anechoic room)		dB <A>	63.5		
Power pressure level (measured in anechoic room)		dB <A>	83.5		
Refrigerant piping diameter	Liquid pipe	mm (in.)	19.05(3/4) Brazed		
	Gas pipe	mm (in.)	34.93(1-3/8) Brazed		

Set Model

Model			PUHY-P350YJM-A(-BS)		PUHY-P400YJM-A(-BS)	
FAN	Type x Quantity		Propeller fan x 1		Propeller fan x 1	
	Air flow rate	m ³ / min	210		210	
		L/s	3,500		3,500	
		cfm	7,415		7,415	
	Control , Driving mechanism		Inverter-control, Direct-driven by motor		Inverter-control, Direct-driven by motor	
*3	Motor output	kW	0.46 x 1		0.46 x 1	
External static press.		0 Pa (0 mmH ₂ O)		0 Pa (0 mmH ₂ O)		
Compressor	Type x Quantity		Inverter scroll hermetic compressor		Inverter scroll hermetic compressor	
	Manufacture		AC&R Works, MITSUBISHI ELECTRIC CORPORATION		AC&R Works, MITSUBISHI ELECTRIC CORPORATION	
	Starting method		Inverter		Inverter	
	Motor output	kW	9.9		10.1	
	Case heater	kW	0.045		0.045	
Lubricant		MEL32		MEL32		
External finish			Pre-coated galvanized steel sheets (+powder coating for -BS type) <MUNSELL 5Y 8/1 or similar>		Pre-coated galvanized steel sheets (+powder coating for -BS type) <MUNSELL 5Y 8/1 or similar>	
External dimension HxWxD		mm	1,710(1,650 without legs) x 1,220 x 760		1,710(1,650 without legs) x 1,220 x 760	
		in.	67-3/8(65 without legs) x 48-1/16 x 29-15/16		67-3/8(65 without legs) x 48-1/16 x 29-15/16	
Protection devices	High pressure protection		High pressure sensor, High pressure switch at 4.15MPa (601 psi)		High pressure sensor, High pressure switch at 4.15MPa (601 psi)	
	Inverter circuit (COMP. / FAN)		Over-heat protection, Over-current protection		Over-heat protection, Over-current protection	
	Compressor		Over-heat protection		Over-heat protection	
	Fan motor		Thermal switch		Thermal switch	
Refrigerant	Type x original charge		R410A x 11.5kg (26lbs)		R410A x 11.5kg (26lbs)	
	Control		LEV and HIC circuit			
Net weight		kg (lbs)	250(552)		250(552)	
Heat exchanger			Salt-resistant cross fin & copper tube		Salt-resistant cross fin & copper tube	
HIC circuit (HIC: Heat Inter-Changer)			Copper pipe,tube-in-tube structure		Copper pipe,tube-in-tube structure	
Pipe between unit and distributor	Liquid pipe	mm (in.)	12.7(1/2) Brazed		15.88(5/8) Brazed	
	Gas pipe	mm (in.)	28.58(1-1/8) Brazed		28.58(1-1/8) Brazed	
Defrosting method			Auto-defrost mode (Reversed refrigerant cycle)			
Drawing	External		WKD94G067			
	Wiring		KE94C449		KE94C449	
Standard attachment	Document		Installation Manual			
	Accessory		Refrigerant conn. pipe			
Optional parts			Outdoor Twinning kit: CMY-Y200VBK2 Joint: CMY-Y102S/L-G2, CMY-Y202/302-G2 Header: CMY-Y104/108/1010-G			
Remarks			Details on foundation work, duct work, insulation work, electrical wiring, power source switch, and other items shall be referred to the Installation Manual. Due to continuing improvement, above specifications may be subject to change without notice.			

Notes :

- Nominal cooling conditions(subject to JIS B8615-1)
Indoor:27°CDB/19°CWB(81°FDB/66°FWB), Outdoor:35°CDB(95°FDB)
Pipe length:7.5m(24-9/16ft.), Level difference:0m(0ft.)
- Nominal heating conditions(subject to JIS B8615-1)
Indoor:20°CDB(68°FDB), Outdoor:7°CDB/6°CWB(45°FDB/43°FWB)
Pipe length:7.5m(24-9/16ft.), Level difference:0m(0ft.)
- External static pressure option is available (30Pa, 60Pa / 3.1mmH₂O, 6.1mmH₂O).

Unit converter

kcal	=kW x 860
BTU/h	=kW x 3,412
cfm	=m ³ /min x 35.31
lb	=kg / 0.4536

*Above specification data is subject to rounding variation.

1. SPECIFICATIONS

DATA G8

Model			PUHY-P800YSJM-A(-BS)		
Power source			3-phase 4-wire 380-400-415V 50/60Hz		
Cooling capacity (Nominal)	*1	kW	90.0		
	*1	kcal / h	77,400		
	*1	BTU / h	307,100		
	Power input		kW	27.10	
	Current input		A	45.7-43.4-41.8	
COP		kW / kW	3.32		
Temp. range of cooling	Indoor	W.B.	15.0~24.0°C(59~75°F)		
	Outdoor	D.B.	-5.0~46.0°C(23~115°F)		
Heating capacity (Nominal)	*2	kW	100.0		
	*2	kcal / h	86,000		
	*2	BTU / h	341,200		
	Power input		kW	25.70	
	Current input		A	43.3-41.2-39.7	
COP		kW / kW	3.89		
Temp. range of heating	Indoor	D.B.	15.0~27.0°C(59~81°F)		
	Outdoor	W.B.	-20.0~15.5°C(-4~60°F)		
Indoor unit connectable	Total capacity		50~130 % of outdoor unit capacity		
	Model / Quantity		P15~P250 / 1~50		
Sound pressure level (measured in anechoic room)		dB <A>	64		
Power pressure level (measured in anechoic room)		dB <A>	84		
Refrigerant piping diameter	Liquid pipe	mm (in.)	19.05(3/4) Brazed		
	Gas pipe	mm (in.)	34.93(1-3/8) Brazed		

Set Model

Model			PUHY-P350YJM-A(-BS)		PUHY-P450YJM-A(-BS)	
FAN	Type x Quantity		Propeller fan x 1		Propeller fan x 2	
	Air flow rate	m ³ / min	210		370	
		L/s	3,500		6,167	
		cfm	7,415		13,065	
	Control , Driving mechanism		Inverter-control, Direct-driven by motor		Inverter-control, Direct-driven by motor	
	Motor output	kW	0.46 x 1		0.46 x 2	
*3	External static press.		0 Pa (0 mmH ₂ O)		0 Pa (0 mmH ₂ O)	
Compressor	Type x Quantity		Inverter scroll hermetic compressor		Inverter scroll hermetic compressor	
	Manufacture		AC&R Works, MITSUBISHI ELECTRIC CORPORATION		AC&R Works, MITSUBISHI ELECTRIC CORPORATION	
	Starting method		Inverter		Inverter	
	Motor output	kW	9.9		11.6	
	Case heater	kW	0.045		0.045	
	Lubricant		MEL32		MEL32	
External finish			Pre-coated galvanized steel sheets (+powder coating for -BS type) <MUNSELL 5Y 8/1 or similar>		Pre-coated galvanized steel sheets (+powder coating for -BS type) <MUNSELL 5Y 8/1 or similar>	
External dimension HxWxD			mm 1,710(1,650 without legs) x 1,220 x 760 in. 67-3/8(65 without legs) x 48-1/16 x 29-15/16		mm 1,710(1,650 without legs) x 1,750 x 760 in. 67-3/8(65 without legs) x 68-15/16 x 29-15/16	
Protection devices	High pressure protection		High pressure sensor, High pressure switch at 4.15MPa (601 psi)		High pressure sensor, High pressure switch at 4.15MPa (601 psi)	
	Inverter circuit (COMP. / FAN)		Over-heat protection, Over-current protection		Over-heat protection, Over-current protection	
	Compressor		Over-heat protection		Over-heat protection	
	Fan motor		Thermal switch		Thermal switch	
Refrigerant	Type x original charge		R410A x 11.5kg (26lbs)		R410A x 11.8kg (27lbs)	
	Control		LEV and HIC circuit			
Net weight		kg (lbs)	250(552)		290(640)	
Heat exchanger			Salt-resistant cross fin & copper tube		Salt-resistant cross fin & copper tube	
HIC circuit (HIC: Heat Inter-Changer)			Copper pipe,tube-in-tube structure		Copper pipe,tube-in-tube structure	
Pipe between unit and distributor	Liquid pipe	mm (in.)	12.7(1/2) Brazed		15.88(5/8) Brazed	
	Gas pipe	mm (in.)	28.58(1-1/8) Brazed		28.58(1-1/8) Brazed	
Defrosting method			Auto-defrost mode (Reversed refrigerant cycle)			
Drawing	External		WKD94G068			
	Wiring		KE94C449		KE94C450	
Standard attachment	Document		Installation Manual			
	Accessory		Refrigerant conn. pipe			
Optional parts			Outdoor Twinning kit: CMY-Y200VBK2 Joint: CMY-Y102S/L-G2, CMY-Y202/302-G2 Header: CMY-Y104/108/1010-G			
Remarks			Details on foundation work, duct work, insulation work, electrical wiring, power source switch, and other items shall be referred to the Installation Manual. Due to continuing improvement, above specifications may be subject to change without notice.			

Notes :

- Nominal cooling conditions(subject to JIS B8615-1)
Indoor:27°CDB/19°CWB(81°FDB/66°FWB), Outdoor:35°CDB(95°FDB)
Pipe length:7.5m(24-9/16ft.), Level difference:0m(0ft.)
- Nominal heating conditions(subject to JIS B8615-1)
Indoor:20°CDB(68°FDB), Outdoor:7°CDB/6°CWB(45°FDB/43°FWB)
Pipe length:7.5m(24-9/16ft.), Level difference:0m(0ft.)
- External static pressure option is available (30Pa, 60Pa / 3.1mmH₂O, 6.1mmH₂O).

Unit converter

kcal	=kW x 860
BTU/h	=kW x 3,412
cfm	=m ³ /min x 35.31
lb	=kg / 0.4536

*Above specification data is subject to rounding variation.

1. SPECIFICATIONS

Model			PUHY-P800YSJM-A1(-BS)		
Power source			3-phase 4-wire 380-400-415V 50/60Hz		
Cooling capacity (Nominal)	*1	kW	90.0		
	*1	kcal / h	77,400		
	*1	BTU / h	307,100		
		Power input	kW	26.86	
		Current input	A	45.3-43.0-41.5	
		COP	kW / kW		3.35
Temp. range of cooling	Indoor	W.B.	15.0~24.0°C(59~75°F)		
	Outdoor	D.B.	-5.0~46.0°C(23~115°F)		
Heating capacity (Nominal)	*2	kW	100.0		
	*2	kcal / h	86,000		
	*2	BTU / h	341,200		
		Power input	kW	27.02	
		Current input	A	45.6-43.3-41.7	
		COP	kW / kW		3.70
Temp. range of heating	Indoor	D.B.	15.0~27.0°C(59~81°F)		
	Outdoor	W.B.	-20.0~15.5°C(-4~60°F)		
Indoor unit connectable	Total capacity	50~130 % of outdoor unit capacity			
	Model / Quantity	P15~P250 / 1~50			
Sound pressure level (measured in anechoic room)		dB <A>	64		
Power pressure level (measured in anechoic room)		dB <A>	84		
Refrigerant piping diameter	Liquid pipe	mm (in.)	19.05(3/4) Brazed		
	Gas pipe	mm (in.)	34.93(1-3/8) Brazed		

Set Model			PUHY-P400YJM-A(-BS)		PUHY-P400YJM-A(-BS)	
Model			Propeller fan x 1		Propeller fan x 1	
FAN	Type x Quantity		210		210	
	Air flow rate	m ³ / min	3,500		3,500	
		L/s	7,415		7,415	
		cfm				
	Control , Driving mechanism		Inverter-control, Direct-driven by motor		Inverter-control, Direct-driven by motor	
*3	Motor output	kW	0.46 x 1		0.46 x 1	
External static press.		0 Pa (0 mmH ₂ O)		0 Pa (0 mmH ₂ O)		
Compressor	Type x Quantity		Inverter scroll hermetic compressor		Inverter scroll hermetic compressor	
	Manufacture		AC&R Works, MITSUBISHI ELECTRIC CORPORATION		AC&R Works, MITSUBISHI ELECTRIC CORPORATION	
	Starting method		Inverter		Inverter	
	Motor output	kW	10.1		10.1	
	Case heater	kW	0.045		0.045	
Lubricant		MEL32		MEL32		
External finish			Pre-coated galvanized steel sheets (+powder coating for -BS type) <MUNSELL 5Y 8/1 or similar>		Pre-coated galvanized steel sheets (+powder coating for -BS type) <MUNSELL 5Y 8/1 or similar>	
External dimension HxWxD			1,710(1,650 without legs) x 1,220 x 760 67-3/8(65 without legs) x 48-1/16 x 29-15/16		1,710(1,650 without legs) x 1,220 x 760 67-3/8(65 without legs) x 48-1/16 x 29-15/16	
Protection devices	High pressure protection		High pressure sensor, High pressure switch at 4.15MPa (601 psi)		High pressure sensor, High pressure switch at 4.15MPa (601 psi)	
	Inverter circuit (COMP. / FAN)		Over-heat protection, Over-current protection		Over-heat protection, Over-current protection	
	Compressor		Over-heat protection		Over-heat protection	
	Fan motor		Thermal switch		Thermal switch	
Refrigerant	Type x original charge		R410A x 11.5kg (26lbs)		R410A x 11.5kg (26lbs)	
	Control		LEV and HIC circuit			
Net weight		kg (lbs)	250(552)		250(552)	
Heat exchanger			Salt-resistant cross fin & copper tube		Salt-resistant cross fin & copper tube	
HIC circuit (HIC: Heat Inter-Changer)			Copper pipe,tube-in-tube structure		Copper pipe,tube-in-tube structure	
Pipe between unit and distributor	Liquid pipe	mm (in.)	15.88(5/8) Brazed		15.88(5/8) Brazed	
	Gas pipe	mm (in.)	28.58(1-1/8) Brazed		28.58(1-1/8) Brazed	
Defrosting method			Auto-defrost mode (Reversed refrigerant cycle)			
Drawing	External		WKD94G067			
	Wiring		KE94C449		KE94C449	
Standard attachment	Document		Installation Manual			
	Accessory		Refrigerant conn. pipe			
Optional parts			Outdoor Twinning kit: CMY-Y200VBK2 Joint: CMY-Y102S/L-G2, CMY-Y202/302-G2 Header: CMY-Y104/108/1010-G			
Remarks			Details on foundation work, duct work, insulation work, electrical wiring, power source switch, and other items shall be referred to the Installation Manual. Due to continuing improvement, above specifications may be subject to change without notice.			

Notes :	Unit converter
1.Nominal cooling conditions(subject to JIS B8615-1) Indoor:27°CDB/19°CWB(81°FDB/66°FWB), Outdoor:35°CDB(95°FDB) Pipe length:7.5m(24-9/16ft.), Level difference:0m(0ft.)	kcal =kW x 860
2.Nominal heating conditions(subject to JIS B8615-1) Indoor:20°CDB(68°FDB), Outdoor:7°CDB/6°CWB(45°FDB/43°FWB) Pipe length:7.5m(24-9/16ft.), Level difference:0m(0ft.)	BTU/h =kW x 3,412
3.External static pressure option is available (30Pa, 60Pa / 3.1mmH ₂ O, 6.1mmH ₂ O).	cfm =m ³ /min x 35.31
	lb =kg / 0.4536
	*Above specification data is subject to rounding variation.

1. SPECIFICATIONS

Model			PUHY-P850YSJM-A(-BS)		
Power source			3-phase 4-wire 380-400-415V 50/60Hz		
Cooling capacity (Nominal)	*1	kW	96.0		
	*1	kcal / h	82,600		
	*1	BTU / h	327,600		
		Power input	kW	29.62	
		Current input	A	50.0-47.5-45.7	
		COP	kW / kW		3.24
Temp. range of cooling	Indoor	W.B.	15.0~24.0°C(59~75°F)		
	Outdoor	D.B.	-5.0~46.0°C(23~115°F)		
Heating capacity (Nominal)	*2	kW	108.0		
	*2	kcal / h	92,900		
	*2	BTU / h	368,500		
		Power input	kW	28.42	
		Current input	A	47.9-45.5-43.9	
		COP	kW / kW		3.80
Temp. range of heating	Indoor	D.B.	15.0~27.0°C(59~81°F)		
	Outdoor	W.B.	-20.0~15.5°C(-4~60°F)		
Indoor unit connectable	Total capacity	50~130 % of outdoor unit capacity			
	Model / Quantity	P15~P250 / 1~50			
Sound pressure level (measured in anechoic room)	dB <A>		64.5		
Power pressure level (measured in anechoic room)	dB <A>		84.5		
Refrigerant piping diameter	Liquid pipe	mm (in.)	19.05(3/4) Brazed		
	Gas pipe	mm (in.)	41.28(1-5/8) Brazed		

Set Model			PUHY-P400YJM-A(-BS)		PUHY-P450YJM-A(-BS)	
Model			Propeller fan x 1		Propeller fan x 2	
FAN	Type x Quantity		210		370	
	Air flow rate	m ³ / min	3,500		6,167	
		L/s	7,415		13,065	
		cfm				
	Control , Driving mechanism		Inverter-control, Direct-driven by motor		Inverter-control, Direct-driven by motor	
Motor output	kW	0.46 x 1		0.46 x 2		
*3	External static press.		0 Pa (0 mmH ₂ O)		0 Pa (0 mmH ₂ O)	
Compressor	Type x Quantity		Inverter scroll hermetic compressor		Inverter scroll hermetic compressor	
	Manufacture		AC&R Works, MITSUBISHI ELECTRIC CORPORATION		AC&R Works, MITSUBISHI ELECTRIC CORPORATION	
	Starting method		Inverter		Inverter	
	Motor output	kW	10.1		11.6	
	Case heater	kW	0.045		0.045	
Lubricant		MEL32		MEL32		
External finish			Pre-coated galvanized steel sheets (+powder coating for -BS type) <MUNSELL 5Y 8/1 or similar>		Pre-coated galvanized steel sheets (+powder coating for -BS type) <MUNSELL 5Y 8/1 or similar>	
External dimension HxWxD			1,710(1,650 without legs) x 1,220 x 760 67-3/8(65 without legs) x 48-1/16 x 29-15/16		1,710(1,650 without legs) x 1,750 x 760 67-3/8(65 without legs) x 68-15/16 x 29-15/16	
Protection devices	High pressure protection		High pressure sensor, High pressure switch at 4.15MPa (601 psi)		High pressure sensor, High pressure switch at 4.15MPa (601 psi)	
	Inverter circuit (COMP. / FAN)		Over-heat protection, Over-current protection		Over-heat protection, Over-current protection	
	Compressor		Over-heat protection		Over-heat protection	
	Fan motor		Thermal switch		Thermal switch	
Refrigerant	Type x original charge		R410A x 11.5kg (26lbs)		R410A x 11.8kg (27lbs)	
	Control		LEV and HIC circuit			
Net weight		kg (lbs)	250(552)		290(640)	
Heat exchanger			Salt-resistant cross fin & copper tube		Salt-resistant cross fin & copper tube	
HIC circuit (HIC: Heat Inter-Changer)			Copper pipe,tube-in-tube structure		Copper pipe,tube-in-tube structure	
Pipe between unit and distributor	Liquid pipe	mm (in.)	15.88(5/8) Brazed		15.88(5/8) Brazed	
	Gas pipe	mm (in.)	28.58(1-1/8) Brazed		28.58(1-1/8) Brazed	
Defrosting method			Auto-defrost mode (Reversed refrigerant cycle)			
Drawing	External		WKD94G068			
	Wiring		KE94C449		KE94C450	
Standard attachment	Document		Installation Manual			
	Accessory		Refrigerant conn. pipe			
Optional parts			Outdoor Twinning kit: CMY-Y200VBK2 Joint: CMY-Y102S/L-G2, CMY-Y202/302-G2 Header: CMY-Y104/108/1010-G			
Remarks			Details on foundation work, duct work, insulation work, electrical wiring, power source switch, and other items shall be referred to the Installation Manual. Due to continuing improvement, above specifications may be subject to change without notice.			

Notes :	Unit converter
1.Nominal cooling conditions(subject to JIS B8615-1) Indoor:27°CDB/19°CWB(81°FDB/66°FWB), Outdoor:35°CDB(95°FDB) Pipe length:7.5m(24-9/16ft.), Level difference:0m(0ft.)	kcal =kW x 860 BTU/h =kW x 3,412
2.Nominal heating conditions(subject to JIS B8615-1) Indoor:20°CDB(68°FDB), Outdoor:7°CDB/6°CWB(45°FDB/43°FWB) Pipe length:7.5m(24-9/16ft.), Level difference:0m(0ft.)	cfm =m ³ /min x 35.31 lb =kg / 0.4536
3.External static pressure option is available (30Pa, 60Pa / 3.1mmH ₂ O, 6.1mmH ₂ O).	*Above specification data is subject to rounding variation.

1. SPECIFICATIONS

Model			PUHY-P900YSJM-A(-BS)		
Power source			3-phase 4-wire 380-400-415V 50/60Hz		
Cooling capacity (Nominal)	*1	kW	101.0		
	*1	kcal / h	86,900		
	*1	BTU / h	344,600		
		Power input	kW	32.06	
		Current input	A	54.1-51.4-49.5	
		COP	kW / kW		3.15
Temp. range of cooling	Indoor	W.B.	15.0~24.0°C(59~75°F)		
	Outdoor	D.B.	-5.0~46.0°C(23~115°F)		
Heating capacity (Nominal)	*2	kW	113.0		
	*2	kcal / h	97,200		
	*2	BTU / h	385,600		
		Power input	kW	30.05	
		Current input	A	50.7-48.1-46.4	
		COP	kW / kW		3.76
Temp. range of heating	Indoor	D.B.	15.0~27.0°C(59~81°F)		
	Outdoor	W.B.	-20.0~15.5°C(-4~60°F)		
Indoor unit connectable	Total capacity		50~130 % of outdoor unit capacity		
	Model / Quantity		P15~P250 / 1~50		
Sound pressure level (measured in anechoic room)		dB <A>	65		
Power pressure level (measured in anechoic room)		dB <A>	85		
Refrigerant piping diameter	Liquid pipe	mm (in.)	19.05(3/4) Brazed		
	Gas pipe	mm (in.)	41.28(1-5/8) Brazed		

Set Model

Model			PUHY-P450YJM-A(-BS)		PUHY-P450YJM-A(-BS)	
FAN	Type x Quantity		Propeller fan x 2		Propeller fan x 2	
	Air flow rate	m ³ / min	370		370	
		L/s	6,167		6,167	
		cfm	13,065		13,065	
	Control , Driving mechanism		Inverter-control, Direct-driven by motor		Inverter-control, Direct-driven by motor	
	*3	Motor output	kW	0.46 x 2		0.46 x 2
External static press.		0 Pa (0 mmH ₂ O)		0 Pa (0 mmH ₂ O)		
Compressor	Type x Quantity		Inverter scroll hermetic compressor		Inverter scroll hermetic compressor	
	Manufacture		AC&R Works, MITSUBISHI ELECTRIC CORPORATION		AC&R Works, MITSUBISHI ELECTRIC CORPORATION	
	Starting method		Inverter		Inverter	
	Motor output	kW	11.6		11.6	
	Case heater	kW	0.045		0.045	
Lubricant		MEL32		MEL32		
External finish			Pre-coated galvanized steel sheets (+powder coating for -BS type) <MUNSELL 5Y 8/1 or similar>		Pre-coated galvanized steel sheets (+powder coating for -BS type) <MUNSELL 5Y 8/1 or similar>	
External dimension HxWxD		mm	1,710(1,650 without legs) x 1,750 x 760		1,710(1,650 without legs) x 1,750 x 760	
		in.	67-3/8(65 without legs) x 68-15/16 x 29-15/16		67-3/8(65 without legs) x 68-15/16 x 29-15/16	
Protection devices	High pressure protection		High pressure sensor, High pressure switch at 4.15MPa (601 psi)		High pressure sensor, High pressure switch at 4.15MPa (601 psi)	
	Inverter circuit (COMP. / FAN)		Over-heat protection, Over-current protection		Over-heat protection, Over-current protection	
	Compressor		Over-heat protection		Over-heat protection	
	Fan motor		Thermal switch		Thermal switch	
Refrigerant	Type x original charge		R410A x 11.8kg (27lbs)		R410A x 11.8kg (27lbs)	
	Control		LEV and HIC circuit		LEV and HIC circuit	
Net weight		kg (lbs)	290(640)		290(640)	
Heat exchanger			Salt-resistant cross fin & copper tube		Salt-resistant cross fin & copper tube	
HIC circuit (HIC: Heat Inter-Changer)			Copper pipe,tube-in-tube structure		Copper pipe,tube-in-tube structure	
Pipe between unit and distributor	Liquid pipe	mm (in.)	15.88(5/8) Brazed		15.88(5/8) Brazed	
	Gas pipe	mm (in.)	28.58(1-1/8) Brazed		28.58(1-1/8) Brazed	
Defrosting method			Auto-defrost mode (Reversed refrigerant cycle)		Auto-defrost mode (Reversed refrigerant cycle)	
Drawing	External		WKD94G069		WKD94G069	
	Wiring		KE94C450		KE94C450	
Standard attachment	Document		Installation Manual		Installation Manual	
	Accessory		Refrigerant conn. pipe		Refrigerant conn. pipe	
Optional parts			Outdoor Twinning kit: CMY-Y200VBK2 Joint: CMY-Y102S/L-G2, CMY-Y202/302-G2 Header: CMY-Y104/108/1010-G		Outdoor Twinning kit: CMY-Y200VBK2 Joint: CMY-Y102S/L-G2, CMY-Y202/302-G2 Header: CMY-Y104/108/1010-G	
Remarks			Details on foundation work, duct work, insulation work, electrical wiring, power source switch, and other items shall be referred to the Installation Manual. Due to continuing improvement, above specifications may be subject to change without notice.		Details on foundation work, duct work, insulation work, electrical wiring, power source switch, and other items shall be referred to the Installation Manual. Due to continuing improvement, above specifications may be subject to change without notice.	

Notes :	Unit converter
1.Nominal cooling conditions(subject to JIS B8615-1) Indoor:27°CDB/19°CWB(81°FDB/66°FWB), Outdoor:35°CDB(95°FDB) Pipe length:7.5m(24-9/16ft.), Level difference:0m(0ft.)	kcal =kW x 860
2.Nominal heating conditions(subject to JIS B8615-1) Indoor:20°CDB(68°FDB), Outdoor:7°CDB/6°CWB(45°FDB/43°FWB) Pipe length:7.5m(24-9/16ft.), Level difference:0m(0ft.)	BTU/h =kW x 3,412
3.External static pressure option is available (30Pa, 60Pa / 3.1mmH ₂ O, 6.1mmH ₂ O).	cfm =m ³ /min x 35.31
	lb =kg / 0.4536
	*Above specification data is subject to rounding variation.

1. SPECIFICATIONS

DATA G8

Model			PUHY-P950YSJM-A(-BS)			
Power source			3-phase 4-wire 380-400-415V 50/60Hz			
Cooling capacity (Nominal)	*1	kW	108.0			
	*1	kcal / h	92,900			
	*1	BTU / h	368,500			
		Power input	kW	30.50		
		Current input	A	51.4-48.9-47.1		
		COP	kW / kW	3.54		
Temp. range of cooling	Indoor	W.B.	15.0~24.0°C(59~75°F)			
	Outdoor	D.B.	-5.0~46.0°C(23~115°F)			
Heating capacity (Nominal)	*2	kW	119.5			
	*2	kcal / h	102,800			
	*2	BTU / h	407,700			
		Power input	kW	30.02		
		Current input	A	50.6-48.1-46.4		
		COP	kW / kW	3.98		
Temp. range of heating	Indoor	D.B.	15.0~27.0°C(59~81°F)			
	Outdoor	W.B.	-20.0~15.5°C(-4~60°F)			
Indoor unit connectable	Total capacity	50~130 % of outdoor unit capacity				
	Model / Quantity	P15~P250 / 1~50				
Sound pressure level (measured in anechoic room)	dB <A>		64.5			
Power pressure level (measured in anechoic room)	dB <A>		84.5			
Refrigerant piping diameter	Liquid pipe	mm (in.)	19.05(3/4) Brazed			
	Gas pipe	mm (in.)	41.28(1-5/8) Brazed			

Set Model			PUHY-P250YJM-A(-BS)	PUHY-P300YJM-A(-BS)	PUHY-P400YJM-A(-BS)	
FAN	Type x Quantity		Propeller fan x 1		Propeller fan x 1	
	Air flow rate	m ³ / min	170		210	
		L/s	2,833		3,500	
		cfm	6,003		7,415	
	Control , Driving mechanism		Inverter-control, Direct-driven by motor		Inverter-control, Direct-driven by motor	
	Motor output	kW	0.46 x 1		0.46 x 1	
	*3	External static press.		0 Pa (0 mmH ₂ O)		0 Pa (0 mmH ₂ O)
Compressor	Type x Quantity		Inverter scroll hermetic compressor		Inverter scroll hermetic compressor	
	Manufacture		AC&R Works, MITSUBISHI ELECTRIC CORPORATION		AC&R Works, MITSUBISHI ELECTRIC CORPORATION	
	Starting method		Inverter		Inverter	
	Motor output	kW	6.8		10.1	
	Case heater	kW	0.035		0.045	
	Lubricant		MEL32		MEL32	
External finish			Pre-coated galvanized steel sheets (+powder coating for -BS type) <MUNSELL 5Y 8/1 or similar>		Pre-coated galvanized steel sheets (+powder coating for -BS type) <MUNSELL 5Y 8/1 or similar>	
External dimension HxWxD			mm 1,710(1,650 without legs) x 920 x 760		mm 1,710(1,650 without legs) x 920 x 760	
			in. 67-3/8(65 without legs) x 36-1/4 x 29-15/16		in. 67-3/8(65 without legs) x 48-1/16 x 29-15/16	
Protection devices	High pressure protection		High pressure sensor, High pressure switch at 4.15MPa (601 psi)		High pressure sensor, High pressure switch at 4.15MPa (601 psi)	
	Inverter circuit (COMP. / FAN)		Over-heat protection, Over-current protection		Over-heat protection, Over-current protection	
	Compressor		Over-heat protection		Over-heat protection	
	Fan motor		Thermal switch		Thermal switch	
Refrigerant	Type x original charge		R410A x 8.0kg (18lbs)		R410A x 8.0kg (18lbs)	
	Control		LEV and HIC circuit		LEV and HIC circuit	
Net weight			kg (lbs) 200(441)		kg (lbs) 215(474)	
Heat exchanger			Salt-resistant cross fin & copper tube		Salt-resistant cross fin & copper tube	
HIC circuit (HIC: Heat Inter-Changer)			Copper pipe,tube-in-tube structure		Copper pipe,tube-in-tube structure	
Pipe between unit and distributor	Liquid pipe	mm (in.)	9.52(3/8) Brazed		12.7(1/2) Brazed	
	Gas pipe	mm (in.)	22.2(7/8) Brazed		22.2(7/8) Brazed	
Defrosting method			Auto-defrost mode (Reversed refrigerant cycle)			
Drawing	External		WKD94G070			
	Wiring		KE94C449		KE94C449	
Standard attachment	Document		Installation Manual			
	Accessory		Refrigerant conn. pipe			
Optional parts			Outdoor Twinning kit: CMY-Y300VBK2 Joint: CMY-Y102S/L-G2, CMY-Y202/302-G2 Header: CMY-Y104/108/1010-G			
Remarks			Details on foundation work, duct work, insulation work, electrical wiring, power source switch, and other items shall be referred to the Installation Manual. Due to continuing improvement, above specifications may be subject to change without notice.			

Notes :	Unit converter
1.Nominal cooling conditions(subject to JIS B8615-1) Indoor:27°CDB/19°CWB(81°FDB/66°FWB), Outdoor:35°CDB(95°FDB) Pipe length:7.5m(24-9/16ft.), Level difference:0m(0ft.)	kcal =kW x 860
2.Nominal heating conditions(subject to JIS B8615-1) Indoor:20°CDB(68°FDB), Outdoor:7°CDB/6°CWB(45°FDB/43°FWB) Pipe length:7.5m(24-9/16ft.), Level difference:0m(0ft.)	BTU/h =kW x 3,412
3.External static pressure option is available (30Pa, 60Pa / 3.1mmH ₂ O, 6.1mmH ₂ O).	cfm =m ³ /min x 35.31
	lb =kg / 0.4536
	*Above specification data is subject to rounding variation.

1. SPECIFICATIONS

Model			PUHY-P1000YSJM-A(-BS)		
Power source			3-phase 4-wire 380-400-415V 50/60Hz		
Cooling capacity (Nominal)	*1	kW	113.0		
	*1	kcal / h	97,200		
	*1	BTU / h	385,600		
		Power input	kW	32.10	
		Current input	A	54.1-51.4-49.6	
		COP	kW / kW		3.52
Temp. range of cooling	Indoor	W.B.	15.0~24.0°C(59~75°F)		
	Outdoor	D.B.	-5.0~46.0°C(23~115°F)		
Heating capacity (Nominal)	*2	kW	127.0		
	*2	kcal / h	109,200		
	*2	BTU / h	433,300		
		Power input	kW	33.15	
		Current input	A	55.9-53.1-51.2	
		COP	kW / kW		3.83
Temp. range of heating	Indoor	D.B.	15.0~27.0°C(59~81°F)		
	Outdoor	W.B.	-20.0~15.5°C(-4~60°F)		
Indoor unit connectable	Total capacity	50~130 % of outdoor unit capacity			
	Model / Quantity	P15~P250 / 2~50			
Sound pressure level (measured in anechoic room)		dB <A>	64.5		
Power pressure level (measured in anechoic room)		dB <A>	84.5		
Refrigerant piping diameter	Liquid pipe	mm (in.)	19.05(3/4) Brazed		
	Gas pipe	mm (in.)	41.28(1-5/8) Brazed		

Set Model

Model			PUHY-P300YJM-A(-BS)	PUHY-P300YJM-A(-BS)	PUHY-P400YJM-A(-BS)
FAN	Type x Quantity		Propeller fan x 1	Propeller fan x 1	Propeller fan x 1
	Air flow rate	m ³ / min	170	170	210
		L/s	2,833	2,833	3,500
		cfm	6,003	6,003	7,415
	Control , Driving mechanism		Inverter-control, Direct-driven by motor	Inverter-control, Direct-driven by motor	Inverter-control, Direct-driven by motor
*3	Motor output	kW	0.46 x 1	0.46 x 1	0.46 x 1
External static press.		0 Pa (0 mmH ₂ O)			
Compressor	Type x Quantity		Inverter scroll hermetic compressor	Inverter scroll hermetic compressor	Inverter scroll hermetic compressor
	Manufacture		AC&R Works, MITSUBISHI ELECTRIC CORPORATION	AC&R Works, MITSUBISHI ELECTRIC CORPORATION	AC&R Works, MITSUBISHI ELECTRIC CORPORATION
	Starting method		Inverter	Inverter	Inverter
	Motor output	kW	7.7	7.7	10.1
	Case heater	kW	0.045	0.045	0.045
	Lubricant		MEL32		
External finish		Pre-coated galvanized steel sheets (+powder coating for -BS type) <MUNSELL 5Y 8/1 or similar>	Pre-coated galvanized steel sheets (+powder coating for -BS type) <MUNSELL 5Y 8/1 or similar>	Pre-coated galvanized steel sheets (+powder coating for -BS type) <MUNSELL 5Y 8/1 or similar>	
External dimension HxWxD	mm	1,710(1,650 without legs) x 920 x 760	1,710(1,650 without legs) x 920 x 760	1,710(1,650 without legs) x 1,220 x 760	
		67-3/8(65 without legs) x 36-1/4 x 29-15/16	67-3/8(65 without legs) x 36-1/4 x 29-15/16	67-3/8(65 without legs) x 48-1/16 x 29-15/16	
Protection devices	High pressure protection		High pressure sensor, High pressure switch at 4.15MPa (601 psi)	High pressure sensor, High pressure switch at 4.15MPa (601 psi)	High pressure sensor, High pressure switch at 4.15MPa (601 psi)
	Inverter circuit (COMP. / FAN)		Over-heat protection, Over-current protection	Over-heat protection, Over-current protection	Over-heat protection, Over-current protection
	Compressor		Over-heat protection	Over-heat protection	Over-heat protection
	Fan motor		Thermal switch	Thermal switch	Thermal switch
Refrigerant	Type x original charge		R410A x 8.0kg (18lbs)	R410A x 8.0kg (18lbs)	R410A x 11.5kg (26lbs)
	Control		LEV and HIC circuit		
Net weight	kg (lbs)	215(474)	215(474)	250(552)	
Heat exchanger		Salt-resistant cross fin & copper tube			
HIC circuit (HIC: Heat Inter-Changer)		Copper pipe,tube-in-tube structure			
Pipe between unit and distributor	Liquid pipe	mm (in.)	12.7(1/2) Brazed	12.7(1/2) Brazed	15.88(5/8) Brazed
	Gas pipe	mm (in.)	22.2(7/8) Brazed	22.2(7/8) Brazed	28.58(1-1/8) Brazed
Defrosting method		Auto-defrost mode (Reversed refrigerant cycle)			
Drawing	External	WKD94G070			
	Wiring	KE94C449	KE94C449	KE94C449	
Standard attachment	Document	Installation Manual			
	Accessory	Refrigerant conn. pipe			
Optional parts		Outdoor Twinning kit: CMY-Y300VBK2 Joint: CMY-Y102S/L-G2, CMY-Y202/302-G2 Header: CMY-Y104/108/1010-G			
Remarks		Details on foundation work, duct work, insulation work, electrical wiring, power source switch, and other items shall be referred to the Installation Manual. Due to continuing improvement, above specifications may be subject to change without notice.			

Notes :

- Nominal cooling conditions(subject to JIS B8615-1)
Indoor:27°CDB/19°CWB(81°FDB/66°FWB), Outdoor:35°CDB(95°FDB)
Pipe length:7.5m(24-9/16ft.), Level difference:0m(0ft.)
- Nominal heating conditions(subject to JIS B8615-1)
Indoor:20°CDB(68°FDB), Outdoor:7°CDB/6°CWB(45°FDB/43°FWB)
Pipe length:7.5m(24-9/16ft.), Level difference:0m(0ft.)
- External static pressure option is available (30Pa, 60Pa / 3.1mmH₂O, 6.1mmH₂O).

Unit converter	
kcal	=kW x 860
BTU/h	=kW x 3,412
cfm	=m ³ /min x 35.31
lb	=kg / 0.4536
*Above specification data is subject to rounding variation.	

1. SPECIFICATIONS

DATA G8

Model			PUHY-P1050YSJM-A(-BS)			
Power source			3-phase 4-wire 380-400-415V 50/60Hz			
Cooling capacity (Nominal)	*1	kW	118.0			
	*1	kcal / h	101,500			
	*1	BTU / h	402,600			
	Power input		kW	33.81		
	Current input		A	57.0-54.2-52.2		
COP		kW / kW	3.49			
Temp. range of cooling	Indoor	W.B.	15.0~24.0°C(59~75°F)			
	Outdoor	D.B.	-5.0~46.0°C(23~115°F)			
Heating capacity (Nominal)	*2	kW	132.0			
	*2	kcal / h	113,500			
	*2	BTU / h	450,400			
	Power input		kW	34.10		
	Current input		A	57.5-54.6-52.7		
COP		kW / kW	3.87			
Temp. range of heating	Indoor	D.B.	15.0~27.0°C(59~81°F)			
	Outdoor	W.B.	-20.0~15.5°C(-4~60°F)			
Indoor unit connectable	Total capacity		50~130 % of outdoor unit capacity			
	Model / Quantity		P15~P250 / 2~50			
Sound pressure level (measured in anechoic room)		dB <A>	65			
Power pressure level (measured in anechoic room)		dB <A>	85			
Refrigerant piping diameter	Liquid pipe	mm (in.)	19.05(3/4) Brazed			
	Gas pipe	mm (in.)	41.28(1-5/8) Brazed			

Set Model

Model			PUHY-P300YJM-A(-BS)	PUHY-P350YJM-A(-BS)	PUHY-P400YJM-A(-BS)	
FAN	Type x Quantity		Propeller fan x 1		Propeller fan x 1	
	Air flow rate	m ³ / min	170		210	
		L/s	2,833		3,500	
		cfm	6,003		7,415	
	Control , Driving mechanism		Inverter-control, Direct-driven by motor		Inverter-control, Direct-driven by motor	
	Motor output	kW	0.46 x 1		0.46 x 1	
*3 External static press.		0 Pa (0 mmH ₂ O)		0 Pa (0 mmH ₂ O)		
Compressor	Type x Quantity		Inverter scroll hermetic compressor		Inverter scroll hermetic compressor	
	Manufacture		AC&R Works, MITSUBISHI ELECTRIC CORPORATION		AC&R Works, MITSUBISHI ELECTRIC CORPORATION	
	Starting method		Inverter		Inverter	
	Motor output	kW	7.7		9.9	
	Case heater	kW	0.045		0.045	
	Lubricant		MEL32		MEL32	
External finish		Pre-coated galvanized steel sheets (+powder coating for -BS type) <MUNSELL 5Y 8/1 or similar>		Pre-coated galvanized steel sheets (+powder coating for -BS type) <MUNSELL 5Y 8/1 or similar>		
External dimension HxWxD		mm	1,710(1,650 without legs) x 920 x 760		1,710(1,650 without legs) x 1,220 x 760	
		in.	67-3/8(65 without legs) x 36-1/4 x 29-15/16		67-3/8(65 without legs) x 48-1/16 x 29-15/16	
Protection devices	High pressure protection		High pressure sensor, High pressure switch at 4.15MPa (601 psi)		High pressure sensor, High pressure switch at 4.15MPa (601 psi)	
	Inverter circuit (COMP. / FAN)		Over-heat protection, Over-current protection		Over-heat protection, Over-current protection	
	Compressor		Over-heat protection		Over-heat protection	
	Fan motor		Thermal switch		Thermal switch	
Refrigerant	Type x original charge		R410A x 8.0kg (18lbs)		R410A x 11.5kg (26lbs)	
	Control		LEV and HIC circuit		LEV and HIC circuit	
Net weight		kg (lbs)	215(474)		250(552)	
Heat exchanger		Salt-resistant cross fin & copper tube		Salt-resistant cross fin & copper tube		
HIC circuit (HIC: Heat Inter-Changer)		Copper pipe,tube-in-tube structure		Copper pipe,tube-in-tube structure		
Pipe between unit and distributor	Liquid pipe	mm (in.)	12.7(1/2) Brazed		15.88(5/8) Brazed	
	Gas pipe	mm (in.)	22.2(7/8) Brazed		28.58(1-1/8) Brazed	
Defrosting method		Auto-defrost mode (Reversed refrigerant cycle)				
Drawing	External		WKD94G074			
	Wiring		KE94C449	KE94C449	KE94C449	
Standard attachment	Document		Installation Manual			
	Accessory		Refrigerant conn. pipe			
Optional parts		Outdoor Twinning kit: CMY-Y300VBK2 Joint: CMY-Y102S/L-G2, CMY-Y202/302-G2 Header: CMY-Y104/108/1010-G				
Remarks		Details on foundation work, duct work, insulation work, electrical wiring, power source switch, and other items shall be referred to the Installation Manual. Due to continuing improvement, above specifications may be subject to change without notice.				

Notes :	Unit converter
1.Nominal cooling conditions(subject to JIS B8615-1) Indoor:27°CDB/19°CWB(81°FDB/66°FWB), Outdoor:35°CDB(95°FDB) Pipe length:7.5m(24-9/16ft.), Level difference:0m(0ft.)	kcal =kW x 860
2.Nominal heating conditions(subject to JIS B8615-1) Indoor:20°CDB(68°FDB), Outdoor:7°CDB/6°CWB(45°FDB/43°FWB) Pipe length:7.5m(24-9/16ft.), Level difference:0m(0ft.)	BTU/h =kW x 3,412
3.External static pressure option is available (30Pa, 60Pa / 3.1mmH ₂ O, 6.1mmH ₂ O).	cfm =m ³ /min x 35.31
	lb =kg / 0.4536
	*Above specification data is subject to rounding variation.

1. SPECIFICATIONS

Model			PUHY-P1100YSJM-A(-BS)			
Power source			3-phase 4-wire 380-400-415V 50/60Hz			
Cooling capacity (Nominal)	*1	kW	124.0			
	*1	kcal / h	106,600			
	*1	BTU / h	423,100			
		Power input	kW	35.73		
		Current input	A	60.3-57.3-55.2		
	COP	kW / kW	3.47			
Temp. range of cooling	Indoor	W.B.	15.0~24.0°C(59~75°F)			
	Outdoor	D.B.	-5.0~46.0°C(23~115°F)			
Heating capacity (Nominal)	*2	kW	140.0			
	*2	kcal / h	120,400			
	*2	BTU / h	477,700			
		Power input	kW	36.08		
		Current input	A	60.9-57.8-55.7		
	COP	kW / kW	3.88			
Temp. range of heating	Indoor	D.B.	15.0~27.0°C(59~81°F)			
	Outdoor	W.B.	-20.0~15.5°C(-4~60°F)			
Indoor unit connectable	Total capacity	50~130 % of outdoor unit capacity				
	Model / Quantity	P15~P250 / 2~50				
Sound pressure level (measured in anechoic room)		dB <A>	65			
Power pressure level (measured in anechoic room)		dB <A>	85			
Refrigerant piping diameter	Liquid pipe	mm (in.)	19.05(3/4) Brazed			
	Gas pipe	mm (in.)	41.28(1-5/8) Brazed			

Set Model

Model			PUHY-P350YJM-A(-BS)	PUHY-P350YJM-A(-BS)	PUHY-P400YJM-A(-BS)	
FAN	Type x Quantity		Propeller fan x 1		Propeller fan x 1	
	Air flow rate	m ³ / min	210		210	
		L/s	3,500		3,500	
		cfm	7,415		7,415	
	Control , Driving mechanism		Inverter-control, Direct-driven by motor		Inverter-control, Direct-driven by motor	
Motor output	kW	0.46 x 1		0.46 x 1		
*3	External static press.		0 Pa (0 mmH ₂ O)		0 Pa (0 mmH ₂ O)	
Compressor	Type x Quantity		Inverter scroll hermetic compressor		Inverter scroll hermetic compressor	
	Manufacture		AC&R Works, MITSUBISHI ELECTRIC CORPORATION		AC&R Works, MITSUBISHI ELECTRIC CORPORATION	
	Starting method		Inverter		Inverter	
	Motor output	kW	9.9		10.1	
	Case heater	kW	0.045		0.045	
	Lubricant		MEL32		MEL32	
External finish			Pre-coated galvanized steel sheets (+powder coating for -BS type) <MUNSELL 5Y 8/1 or similar>		Pre-coated galvanized steel sheets (+powder coating for -BS type) <MUNSELL 5Y 8/1 or similar>	
External dimension HxWxD	mm		1,710(1,650 without legs) x 1,220 x 760		1,710(1,650 without legs) x 1,220 x 760	
	in.		67-3/8(65 without legs) x 48-1/16 x 29-15/16		67-3/8(65 without legs) x 48-1/16 x 29-15/16	
Protection devices	High pressure protection		High pressure sensor, High pressure switch at 4.15MPa (601 psi)		High pressure sensor, High pressure switch at 4.15MPa (601 psi)	
	Inverter circuit (COMP. / FAN)		Over-heat protection, Over-current protection		Over-heat protection, Over-current protection	
	Compressor		Over-heat protection		Over-heat protection	
	Fan motor		Thermal switch		Thermal switch	
Refrigerant	Type x original charge		R410A x 11.5kg (26lbs)		R410A x 11.5kg (26lbs)	
	Control		LEV and HIC circuit			
Net weight	kg (lbs)	250(552)		250(552)		
Heat exchanger			Salt-resistant cross fin & copper tube		Salt-resistant cross fin & copper tube	
HIC circuit (HIC: Heat Inter-Changer)			Copper pipe,tube-in-tube structure		Copper pipe,tube-in-tube structure	
Pipe between unit and distributor	Liquid pipe	mm (in.)	12.7(1/2) Brazed		15.88(5/8) Brazed	
	Gas pipe	mm (in.)	28.58(1-1/8) Brazed		28.58(1-1/8) Brazed	
Defrosting method			Auto-defrost mode (Reversed refrigerant cycle)			
Drawing	External		WKD94G072			
	Wiring		KE94C449		KE94C449	
Standard attachment	Document		Installation Manual			
	Accessory		Refrigerant conn. pipe			
Optional parts			Outdoor Twinning kit: CMY-Y300VBK2 Joint: CMY-Y102S/L-G2, CMY-Y202/302-G2 Header: CMY-Y104/108/1010-G			
Remarks			Details on foundation work, duct work, insulation work, electrical wiring, power source switch, and other items shall be referred to the Installation Manual. Due to continuing improvement, above specifications may be subject to change without notice.			

Notes :

- Nominal cooling conditions(subject to JIS B8615-1)
Indoor:27°CDB/19°CWB(81°FDB/66°FWB), Outdoor:35°CDB(95°FDB)
Pipe length:7.5m(24-9/16ft.), Level difference:0m(0ft.)
- Nominal heating conditions(subject to JIS B8615-1)
Indoor:20°CDB(68°FDB), Outdoor:7°CDB/6°CWB(45°FDB/43°FWB)
Pipe length:7.5m(24-9/16ft.), Level difference:0m(0ft.)
- External static pressure option is available (30Pa, 60Pa / 3.1mmH₂O, 6.1mmH₂O).

Unit converter	
kcal	=kW x 860
BTU/h	=kW x 3,412
cfm	=m ³ /min x 35.31
lb	=kg / 0.4536
*Above specification data is subject to rounding variation.	

1. SPECIFICATIONS

DATA G8

Model			PUHY-P1150YSJM-A(-BS)		
Power source			3-phase 4-wire 380-400-415V 50/60Hz		
Cooling capacity (Nominal)	*1	kW	130.0		
	*1	kcal / h	111,800		
	*1	BTU / h	443,600		
		Power input	kW	38.34	
		Current input	A	64.7-61.4-59.2	
		COP	kW / kW	3.39	
Temp. range of cooling	Indoor	W.B.	15.0~24.0°C(59~75°F)		
	Outdoor	D.B.	-5.0~46.0°C(23~115°F)		
Heating capacity (Nominal)	*2	kW	145.0		
	*2	kcal / h	124,700		
	*2	BTU / h	494,700		
		Power input	kW	37.27	
		Current input	A	62.9-59.7-57.6	
		COP	kW / kW	3.89	
Temp. range of heating	Indoor	D.B.	15.0~27.0°C(59~81°F)		
	Outdoor	W.B.	-20.0~15.5°C(-4~60°F)		
Indoor unit connectable	Total capacity	50~130 % of outdoor unit capacity			
	Model / Quantity	P15~P250 / 2~50			
Sound pressure level (measured in anechoic room)	dB <A>		65.5		
Power pressure level (measured in anechoic room)	dB <A>		85.5		
Refrigerant piping diameter	Liquid pipe	mm (in.)	19.05(3/4) Brazed		
	Gas pipe	mm (in.)	41.28(1-5/8) Brazed		

Set Model			PUHY-P350YJM-A(-BS)	PUHY-P350YJM-A(-BS)	PUHY-P450YJM-A(-BS)
FAN	Type x Quantity		Propeller fan x 1	Propeller fan x 1	Propeller fan x 2
	Air flow rate	m ³ / min	210	210	370
		L/s	3,500	3,500	6,167
		cfm	7,415	7,415	13,065
	Control , Driving mechanism		Inverter-control, Direct-driven by motor	Inverter-control, Direct-driven by motor	Inverter-control, Direct-driven by motor
	Motor output	kW	0.46 x 1	0.46 x 1	0.46 x 2
*3	External static press.		0 Pa (0 mmH ₂ O)	0 Pa (0 mmH ₂ O)	0 Pa (0 mmH ₂ O)
Compressor	Type x Quantity		Inverter scroll hermetic compressor	Inverter scroll hermetic compressor	Inverter scroll hermetic compressor
	Manufacture		AC&R Works, MITSUBISHI ELECTRIC CORPORATION	AC&R Works, MITSUBISHI ELECTRIC CORPORATION	AC&R Works, MITSUBISHI ELECTRIC CORPORATION
	Starting method		Inverter	Inverter	Inverter
	Motor output	kW	9.9	9.9	11.6
	Case heater	kW	0.045	0.045	0.045
	Lubricant		MEL32	MEL32	MEL32
External finish			Pre-coated galvanized steel sheets (+powder coating for -BS type) <MUNSELL 5Y 8/1 or similar>	Pre-coated galvanized steel sheets (+powder coating for -BS type) <MUNSELL 5Y 8/1 or similar>	Pre-coated galvanized steel sheets (+powder coating for -BS type) <MUNSELL 5Y 8/1 or similar>
External dimension HxWxD			mm 1,710(1,650 without legs) x 1,220 x 760 in. 67-3/8(65 without legs) x 48-1/16 x 29-15/16	mm 1,710(1,650 without legs) x 1,220 x 760 in. 67-3/8(65 without legs) x 48-1/16 x 29-15/16	mm 1,710(1,650 without legs) x 1,750 x 760 in. 67-3/8(65 without legs) x 68-15/16 x 29-15/16
Protection devices	High pressure protection		High pressure sensor, High pressure switch at 4.15MPa (601 psi)	High pressure sensor, High pressure switch at 4.15MPa (601 psi)	High pressure sensor, High pressure switch at 4.15MPa (601 psi)
	Inverter circuit (COMP. / FAN)		Over-heat protection, Over-current protection	Over-heat protection, Over-current protection	Over-heat protection, Over-current protection
	Compressor		Over-heat protection	Over-heat protection	Over-heat protection
	Fan motor		Thermal switch	Thermal switch	Thermal switch
Refrigerant	Type x original charge		R410A x 11.5kg (26lbs)	R410A x 11.5kg (26lbs)	R410A x 11.8kg (27lbs)
	Control		LEV and HIC circuit		
Net weight	kg (lbs)		250(552)	250(552)	290(640)
Heat exchanger			Salt-resistant cross fin & copper tube	Salt-resistant cross fin & copper tube	Salt-resistant cross fin & copper tube
HIC circuit (HIC: Heat Inter-Changer)			Copper pipe,tube-in-tube structure	Copper pipe,tube-in-tube structure	Copper pipe,tube-in-tube structure
Pipe between unit and distributor	Liquid pipe	mm (in.)	12.7(1/2) Brazed	12.7(1/2) Brazed	15.88(5/8) Brazed
	Gas pipe	mm (in.)	28.58(1-1/8) Brazed	28.58(1-1/8) Brazed	28.58(1-1/8) Brazed
Defrosting method			Auto-defrost mode (Reversed refrigerant cycle)		
Drawing	External		WKD94G073		
	Wiring		KE94C449	KE94C449	KE94C450
Standard attachment	Document		Installation Manual		
	Accessory		Refrigerant conn. pipe		
Optional parts			Outdoor Twinning kit: CMY-Y300VBK2 Joint: CMY-Y102S/L-G2, CMY-Y202/302-G2 Header: CMY-Y104/108/1010-G		
Remarks			Details on foundation work, duct work, insulation work, electrical wiring, power source switch, and other items shall be referred to the Installation Manual. Due to continuing improvement, above specifications may be subject to change without notice.		

Notes :	Unit converter
1.Nominal cooling conditions(subject to JIS B8615-1) Indoor:27°CDB/19°CWB(81°FDB/66°FWB), Outdoor:35°CDB(95°FDB) Pipe length:7.5m(24-9/16ft.), Level difference:0m(0ft.)	kcal =kW x 860 BTU/h =kW x 3,412
2.Nominal heating conditions(subject to JIS B8615-1) Indoor:20°CDB(68°FDB), Outdoor:7°CDB/6°CWB(45°FDB/43°FWB) Pipe length:7.5m(24-9/16ft.), Level difference:0m(0ft.)	cfm =m ³ /min x 35.31 lb =kg / 0.4536
3.External static pressure option is available (30Pa, 60Pa / 3.1mmH ₂ O, 6.1mmH ₂ O).	*Above specification data is subject to rounding variation.

1. SPECIFICATIONS

Model			PUHY-P1200YSJM-A(-BS)			
Power source			3-phase 4-wire 380-400-415V 50/60Hz			
Cooling capacity (Nominal)	*1	kW	136.0			
	*1	kcal / h	117,000			
	*1	BTU / h	464,000			
		Power input	kW	40.84		
		Current input	A	68.9-65.4-63.1		
		COP	kW / kW	3.33		
Temp. range of cooling	Indoor	W.B.	15.0~24.0°C(59~75°F)			
	Outdoor	D.B.	-5.0~46.0°C(23~115°F)			
Heating capacity (Nominal)	*2	kW	150.0			
	*2	kcal / h	129,000			
	*2	BTU / h	511,800			
		Power input	kW	39.26		
		Current input	A	66.2-62.9-60.6		
		COP	kW / kW	3.82		
Temp. range of heating	Indoor	D.B.	15.0~27.0°C(59~81°F)			
	Outdoor	W.B.	-20.0~15.5°C(-4~60°F)			
Indoor unit connectable	Total capacity	50~130 % of outdoor unit capacity				
	Model / Quantity	P15~P250 / 2~50				
Sound pressure level (measured in anechoic room)		dB <A>	66			
Power pressure level (measured in anechoic room)		dB <A>	86			
Refrigerant piping diameter	Liquid pipe	mm (in.)	19.05(3/4) Brazed			
	Gas pipe	mm (in.)	41.28(1-5/8) Brazed			

Set Model

Model			PUHY-P350YJM-A(-BS)	PUHY-P400YJM-A(-BS)	PUHY-P450YJM-A(-BS)	
FAN	Type x Quantity		Propeller fan x 1		Propeller fan x 2	
	Air flow rate	m ³ / min	210		370	
		L/s	3,500		6,167	
		cfm	7,415		13,065	
	Control , Driving mechanism		Inverter-control, Direct-driven by motor		Inverter-control, Direct-driven by motor	
Motor output	kW	0.46 x 1		0.46 x 2		
*3	External static press.		0 Pa (0 mmH ₂ O)		0 Pa (0 mmH ₂ O)	
Compressor	Type x Quantity		Inverter scroll hermetic compressor		Inverter scroll hermetic compressor	
	Manufacture		AC&R Works, MITSUBISHI ELECTRIC CORPORATION		AC&R Works, MITSUBISHI ELECTRIC CORPORATION	
	Starting method		Inverter		Inverter	
	Motor output	kW	9.9		11.6	
	Case heater	kW	0.045		0.045	
	Lubricant		MEL32		MEL32	
External finish			Pre-coated galvanized steel sheets (+powder coating for -BS type) <MUNSELL 5Y 8/1 or similar>		Pre-coated galvanized steel sheets (+powder coating for -BS type) <MUNSELL 5Y 8/1 or similar>	
External dimension HxWxD	mm		1,710(1,650 without legs) x 1,220 x 760		1,710(1,650 without legs) x 1,220 x 760	
	in.		67-3/8(65 without legs) x 48-1/16 x 29-15/16		67-3/8(65 without legs) x 48-1/16 x 29-15/16	
Protection devices	High pressure protection		High pressure sensor, High pressure switch at 4.15MPa (601 psi)		High pressure sensor, High pressure switch at 4.15MPa (601 psi)	
	Inverter circuit (COMP. / FAN)		Over-heat protection, Over-current protection		Over-heat protection, Over-current protection	
	Compressor		Over-heat protection		Over-heat protection	
	Fan motor		Thermal switch		Thermal switch	
Refrigerant	Type x original charge		R410A x 11.5kg (26lbs)		R410A x 11.8kg (27lbs)	
	Control		LEV and HIC circuit			
Net weight	kg (lbs)	250(552)		290(640)		
Heat exchanger			Salt-resistant cross fin & copper tube		Salt-resistant cross fin & copper tube	
HIC circuit (HIC: Heat Inter-Changer)			Copper pipe,tube-in-tube structure		Copper pipe,tube-in-tube structure	
Pipe between unit and distributor	Liquid pipe	mm (in.)	12.7(1/2) Brazed		15.88(5/8) Brazed	
	Gas pipe	mm (in.)	28.58(1-1/8) Brazed		28.58(1-1/8) Brazed	
Defrosting method			Auto-defrost mode (Reversed refrigerant cycle)			
Drawing	External		WKD94G073			
	Wiring		KE94C449		KE94C450	
Standard attachment	Document		Installation Manual			
	Accessory		Refrigerant conn. pipe			
Optional parts			Outdoor Twinning kit: CMY-Y300VBK2 Joint: CMY-Y102S/L-G2, CMY-Y202/302-G2 Header: CMY-Y104/108/1010-G			
Remarks			Details on foundation work, duct work, insulation work, electrical wiring, power source switch, and other items shall be referred to the Installation Manual. Due to continuing improvement, above specifications may be subject to change without notice.			

Notes :

- Nominal cooling conditions(subject to JIS B8615-1)
Indoor:27°CDB/19°CWB(81°FDB/66°FWB), Outdoor:35°CDB(95°FDB)
Pipe length:7.5m(24-9/16ft.), Level difference:0m(0ft.)
- Nominal heating conditions(subject to JIS B8615-1)
Indoor:20°CDB(68°FDB), Outdoor:7°CDB/6°CWB(45°FDB/43°FWB)
Pipe length:7.5m(24-9/16ft.), Level difference:0m(0ft.)
- External static pressure option is available (30Pa, 60Pa / 3.1mmH₂O, 6.1mmH₂O).

Unit converter	
kcal	=kW x 860
BTU/h	=kW x 3,412
cfm	=m ³ /min x 35.31
lb	=kg / 0.4536
*Above specification data is subject to rounding variation.	

1. SPECIFICATIONS

DATA G8

Model			PUHY-P1250YSJM-A(-BS)		
Power source			3-phase 4-wire 380-400-415V 50/60Hz		
Cooling capacity (Nominal)	*1	kW	140.0		
	*1	kcal / h	120,400		
	*1	BTU / h	477,700		
		Power input	kW	42.94	
		Current input	A	72.4-68.8-66.3	
		COP	kW / kW	3.26	
Temp. range of cooling	Indoor	W.B.	15.0~24.0°C(59~75°F)		
	Outdoor	D.B.	-5.0~46.0°C(23~115°F)		
Heating capacity (Nominal)	*2	kW	156.5		
	*2	kcal / h	134,600		
	*2	BTU / h	534,000		
		Power input	kW	40.86	
		Current input	A	68.9-65.5-63.1	
		COP	kW / kW	3.83	
Temp. range of heating	Indoor	D.B.	15.0~27.0°C(59~81°F)		
	Outdoor	W.B.	-20.0~15.5°C(-4~60°F)		
Indoor unit connectable	Total capacity		50~130 % of outdoor unit capacity		
	Model / Quantity		P15~P250 / 2~50		
Sound pressure level (measured in anechoic room)		dB <A>	66		
Power pressure level (measured in anechoic room)		dB <A>	86		
Refrigerant piping diameter	Liquid pipe	mm (in.)	19.05(3/4) Brazed		
	Gas pipe	mm (in.)	41.28(1-5/8) Brazed		

Set Model			PUHY-P350YJM-A(-BS)		PUHY-P450YJM-A(-BS)		PUHY-P450YJM-A(-BS)	
FAN	Type x Quantity		Propeller fan x 1		Propeller fan x 2		Propeller fan x 2	
	Air flow rate	m ³ / min	210		370		370	
		L/s	3,500		6,167		6,167	
		cfm	7,415		13,065		13,065	
	Control , Driving mechanism		Inverter-control, Direct-driven by motor		Inverter-control, Direct-driven by motor		Inverter-control, Direct-driven by motor	
	Motor output	kW	0.46 x 1		0.46 x 2		0.46 x 2	
*3	External static press.		0 Pa (0 mmH ₂ O)		0 Pa (0 mmH ₂ O)		0 Pa (0 mmH ₂ O)	
Compressor	Type x Quantity		Inverter scroll hermetic compressor		Inverter scroll hermetic compressor		Inverter scroll hermetic compressor	
	Manufacture		AC&R Works, MITSUBISHI ELECTRIC CORPORATION		AC&R Works, MITSUBISHI ELECTRIC CORPORATION		AC&R Works, MITSUBISHI ELECTRIC CORPORATION	
	Starting method		Inverter		Inverter		Inverter	
	Motor output	kW	9.9		11.6		11.6	
	Case heater	kW	0.045		0.045		0.045	
	Lubricant		MEL32		MEL32		MEL32	
External finish			Pre-coated galvanized steel sheets (+powder coating for -BS type) <MUNSELL 5Y 8/1 or similar>		Pre-coated galvanized steel sheets (+powder coating for -BS type) <MUNSELL 5Y 8/1 or similar>		Pre-coated galvanized steel sheets (+powder coating for -BS type) <MUNSELL 5Y 8/1 or similar>	
External dimension HxWxD			mm	1,710(1,650 without legs) x 1,220 x 760	1,710(1,650 without legs) x 1,750 x 760	1,710(1,650 without legs) x 1,750 x 760	1,710(1,650 without legs) x 1,750 x 760	
			in.	67-3/8(65 without legs) x 48-1/16 x 29-15/16	67-3/8(65 without legs) x 68-15/16 x 29-15/16	67-3/8(65 without legs) x 68-15/16 x 29-15/16	67-3/8(65 without legs) x 68-15/16 x 29-15/16	
Protection devices	High pressure protection		High pressure sensor, High pressure switch at 4.15MPa (601 psi)		High pressure sensor, High pressure switch at 4.15MPa (601 psi)		High pressure sensor, High pressure switch at 4.15MPa (601 psi)	
	Inverter circuit (COMP. / FAN)		Over-heat protection, Over-current protection		Over-heat protection, Over-current protection		Over-heat protection, Over-current protection	
	Compressor		Over-heat protection		Over-heat protection		Over-heat protection	
	Fan motor		Thermal switch		Thermal switch		Thermal switch	
Refrigerant	Type x original charge		R410A x 11.5kg (26lbs)		R410A x 11.8kg (27lbs)		R410A x 11.8kg (27lbs)	
	Control				LEV and HIC circuit			
Net weight			kg (lbs)	250(552)	290(640)	290(640)	290(640)	
Heat exchanger			Salt-resistant cross fin & copper tube		Salt-resistant cross fin & copper tube		Salt-resistant cross fin & copper tube	
HIC circuit (HIC: Heat Inter-Changer)			Copper pipe,tube-in-tube structure		Copper pipe,tube-in-tube structure		Copper pipe,tube-in-tube structure	
Pipe between unit and distributor	Liquid pipe	mm (in.)	12.7(1/2) Brazed		15.88(5/8) Brazed		15.88(5/8) Brazed	
	Gas pipe	mm (in.)	28.58(1-1/8) Brazed		28.58(1-1/8) Brazed		28.58(1-1/8) Brazed	
Defrosting method			Auto-defrost mode (Reversed refrigerant cycle)					
Drawing	External		WKD94G074					
	Wiring		KE94C449	KE94C450	KE94C450	KE94C450	KE94C450	
Standard attachment	Document		Installation Manual					
	Accessory		Refrigerant conn. pipe					
Optional parts			Outdoor Twinning kit: CMY-Y300VBK2 Joint: CMY-Y102S/L-G2, CMY-Y202/302-G2 Header: CMY-Y104/108/1010-G					
Remarks			Details on foundation work, duct work, insulation work, electrical wiring, power source switch, and other items shall be referred to the Installation Manual. Due to continuing improvement, above specifications may be subject to change without notice.					

Notes :	Unit converter
1.Nominal cooling conditions(subject to JIS B8615-1) Indoor:27°CDB/19°CWB(81°FDB/66°FWB), Outdoor:35°CDB(95°FDB) Pipe length:7.5m(24-9/16ft.), Level difference:0m(0ft.)	kcal =kW x 860 BTU/h =kW x 3,412
2.Nominal heating conditions(subject to JIS B8615-1) Indoor:20°CDB(68°FDB), Outdoor:7°CDB/6°CWB(45°FDB/43°FWB) Pipe length:7.5m(24-9/16ft.), Level difference:0m(0ft.)	cfm =m ³ /min x 35.31 lb =kg / 0.4536
3.External static pressure option is available (30Pa, 60Pa / 3.1mmH ₂ O, 6.1mmH ₂ O).	*Above specification data is subject to rounding variation.

PUHY-P200,250,300YJM-A(-BS)

Unit : mm

- <Accessories>
 ● Connecting pipe
 <Gas>
 • Elbow (IDø19.05XODø19.05).....P200 1pc.
 • Elbow (IDø25.4XODø25.4).....P250,P300 1pc.
 • Pipe (IDø25.4XODø22.2).....P250,P300 1pc.
 <Liquid>
 • Pipe (IDø9.52XODø9.52).....P200,P250 1pc.
 • Pipe (IDø12.7XODø12.7).....P300 1pc.
 • Pipe (IDø12.7XODø9.52).....P300 1pc.

Note 1. Please refer to the next page for information regarding necessary spacing around the unit and foundation work.
 2. The detachable leg can be removed at site.
 3. At brazing of pipes, wrap the refrigerant service valve with wet cloth and keep the temperature of refrigerant service valve under 120°C

NC.	Usage	Specifications
①	Front through hole	102X72 Knockout hole
②	Bottom through hole	150X92 Knockout hole
③	Front through hole	ø65 or ø40 Knockout hole
④	Front through hole	ø52 or ø27 Knockout hole
⑤	Bottom through hole	ø52 Knockout hole
⑥	For transmission cables	ø34 Knockout hole

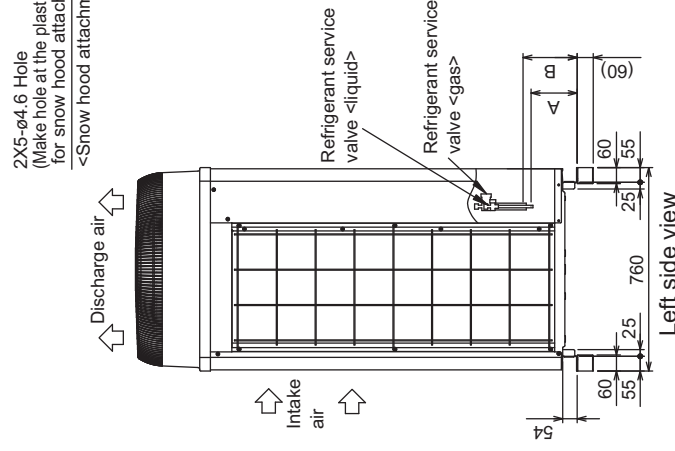
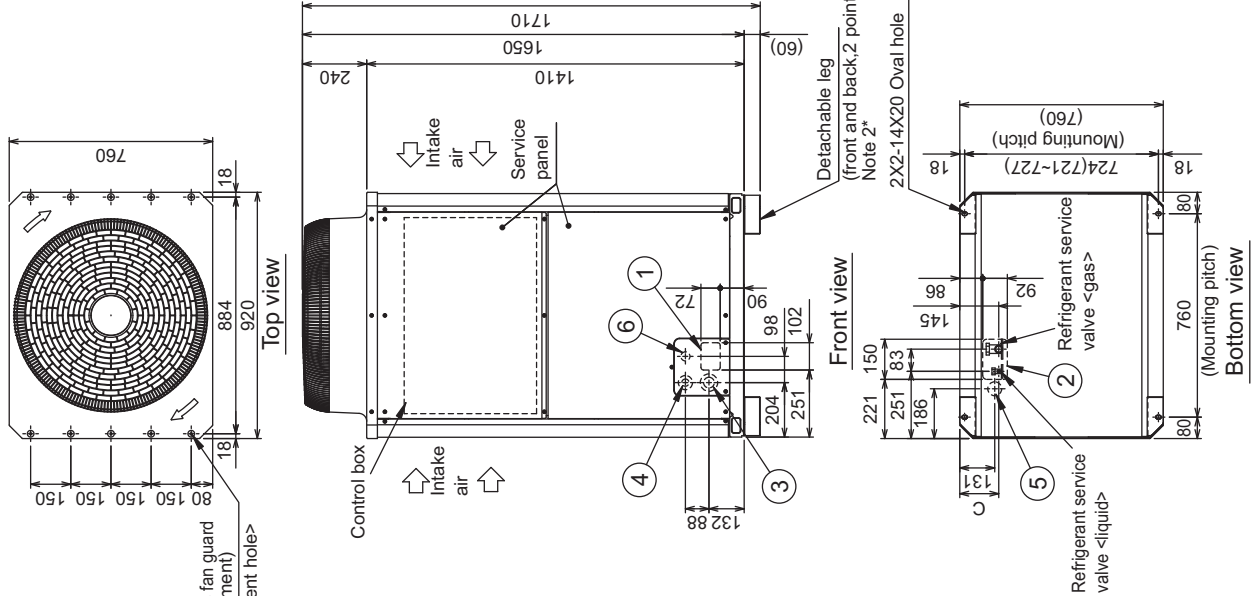

Connecting pipe specifications

Model	Position dimensions for the refrigerant service valve		Connection specifications for the refrigerant service valve*1	
	Liquid	Gas	Liquid	Gas
PUHY-P200YJM	142	170	ø9.52 Brazed	ø19.05 Brazed
PUHY-P250YJM	145	172	ø9.52 Brazed (ø12.7 Brazed)*3	ø22.2 Brazed
PUHY-P300YJM	143	150	ø9.52 Brazed (ø12.7 Brazed)*4	ø22.2 Brazed

*1 Connect by using the connecting pipes (for bottom piping and front piping) that are supplied.
 *2 Indicates dimensions and connection specifications in the case the unit is used in combination with other outdoor units.
 *3 Total length=90mm
 *4 Total length>=40mm

PUHY-P200,250,300YJM-A(-BS)

Unit : mm

1. Required space around the unit

● In case of single installation

- ① Secure enough space around the unit as shown in the figure below.
 - With a space of at least 300mm to the wall on the back of the unit

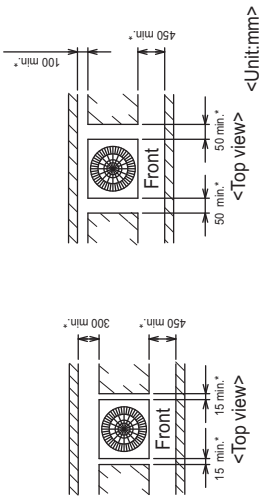

- ② When the height of the walls on the front, back or on the sides <H> exceeds the wall height limit as defined below add the height that exceeds the height limit <h> to the figures that are marked with an asterisk.

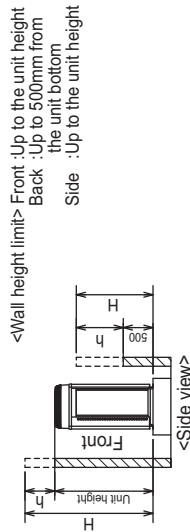

<Wall height limit> Front : Up to the unit height
 Back : Up to 500mm from the unit bottom
 Side : Up to the unit height

● In case of collective installation

- ① When multiple units are installed adjacent to each other, secure enough space to allow for air circulation and walkway between groups of units as shown in the figures below.
- ② At least two sides must be left open.
- ③ As with the single installation, add the height that exceeds the height limit <h> to the figures that are marked with an asterisk.
- ④ If there is a wall at both the front and the rear of the unit, install up to six units consecutively in the side direction and provide a space of 1000mm or more as inlet space/ passage space for each six units.

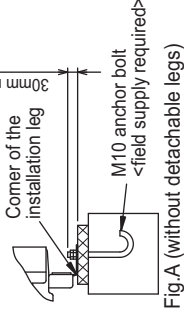
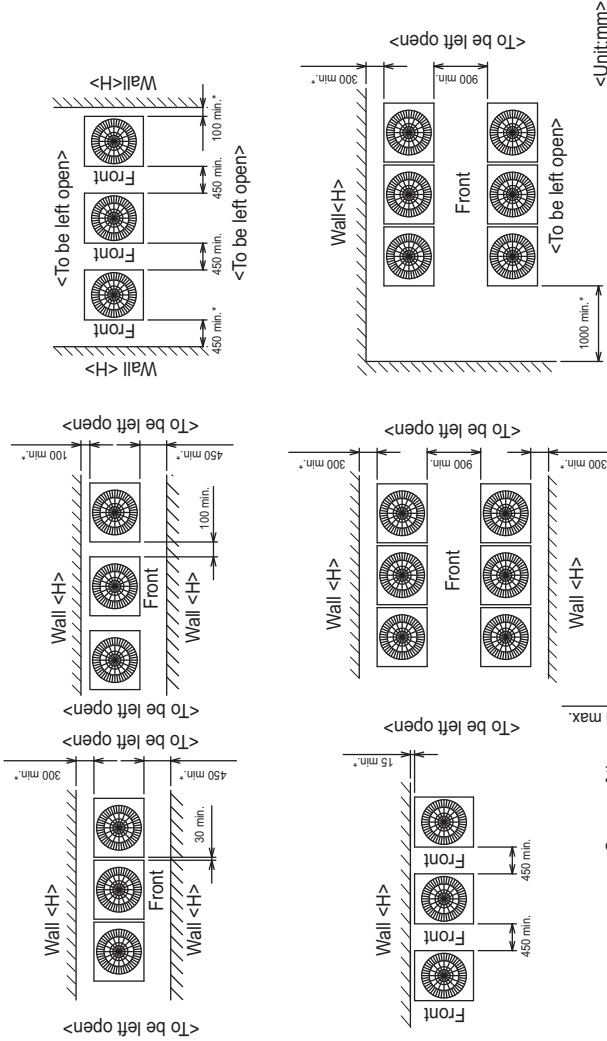

Fig.A (without detachable legs)

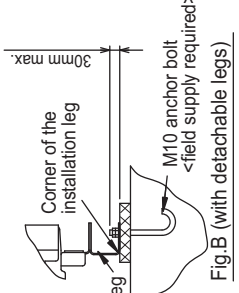

Fig.B (with detachable legs)

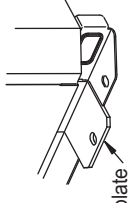

Fig.C (without detachable legs)

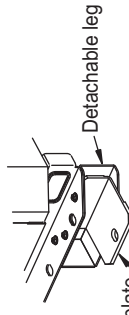

Fig.D (with detachable legs)

2. Foundation work

- ① Take into consideration the surface strength, water drainage route, piping route, and wiring route when preparing the installation site.
- ② Note that the drain water comes out of the unit during operation.
- ③ Build the foundation in such way that the corner of the installation leg is securely supported as shown in the right figure. (Fig.A, B)
 When using a rubber isolating cushion, please ensure it is large enough to cover the entire width of each of the unit's legs.
- ④ The protrusion length of the anchor bolt must not exceed 30mm. (Fig.A, B)
- ⑤ Use four fixing plates as shown in the right figure. <field supply required>
 when using post-installed anchor bolts. (Fig. C, D)
- ⑥ To prevent small animals and water and snow from entering the unit and damaging its parts, close the gap around the edges of through holes for pipes and wires with filler plates <field supply required>.
- ⑦ When the pipes or cables are routed at the bottom of the unit, make sure that the through hole at the base of the unit does not get blocked with the installation base.
- ⑧ Refer to the Installation Manual when installing units on an installation base.

PUHY-P350,400YJM-A-(BS)

Unit : mm

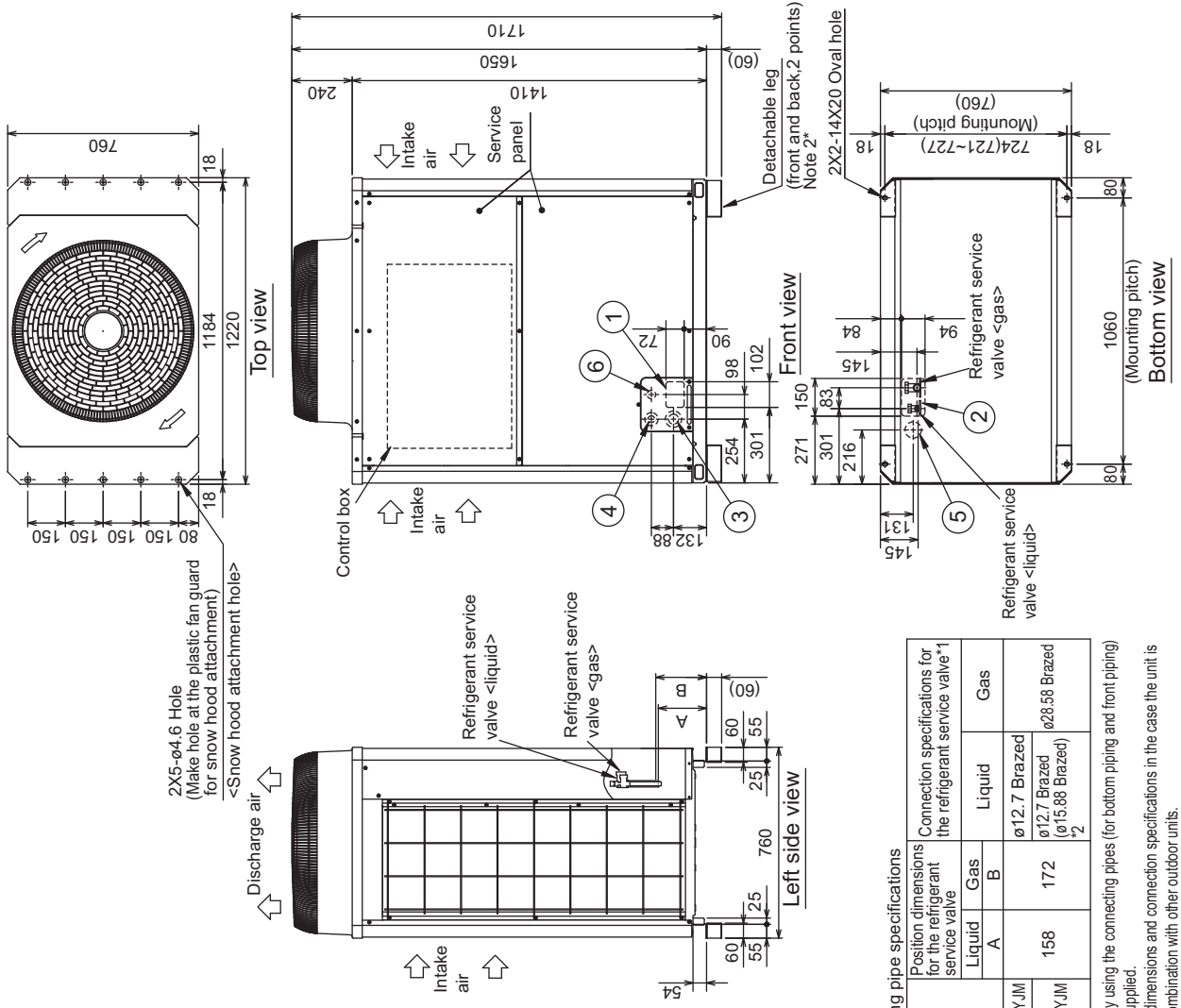

- <Accessories>
 ● Connecting pipe
 <Gas>
 • Elbow (IDø25.4XODø25.4) 1pc.
 • Pipe (IDø25.4XODø28.58) 1pc.
 <Liquid>
 • Pipe (IDø15.88XODø15.88) 1pc.
 • Pipe (IDø15.88XODø12.7) 1pc.

Note 1. Please refer to the next page for information regarding necessary spacing around the unit and foundation work.
 2. The detachable leg can be removed at site.
 3. At brazing of pipes, wrap the refrigerant service valve with wet cloth and keep the temperature of refrigerant service valve under 120°C

NO.	Usage	Specifications
①	Front through hole	102×72 Knockout hole
②	Bottom through hole	150×94 Knockout hole
③	Front through hole	ø65 or ø40 Knockout hole
④	Front through hole	ø52 or ø27 Knockout hole
⑤	Bottom through hole	ø65 Knockout hole
⑥	For transmission cables	ø34 Knockout hole

Model	Position dimensions for the refrigerant service valve*1		Connection specifications for the refrigerant service valve*1	
	Liquid	Gas	Liquid	Gas
PUHY-P350YJM	158	172	ø12.7 Brazed (ø15.88 Brazed)*2	ø28.58 Brazed
PUHY-P400YJM				

*1 Connect by using the connecting pipes (for bottom piping and front piping) that are supplied.
 *2 Indicates dimensions and connection specifications in the case the unit is used in combination with other outdoor units.

PUHY-P350,400YJM-A(-BS)

Unit : mm

1. Required space around the unit

● In case of single installation

- ① Secure enough space around the unit as shown in the figure below.
 - With a space of at least 300mm to the wall on the back of the unit

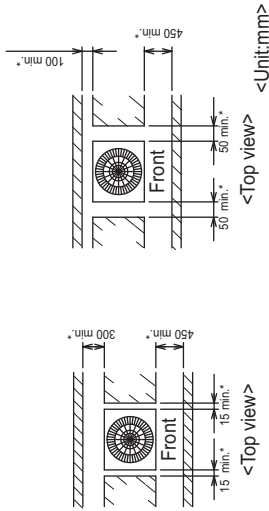

- ② When the height of the walls on the front, back or on the sides <H> exceeds the wall height limit as defined below add the height that exceeds the height limit <h> to the figures that are marked with an asterisk.

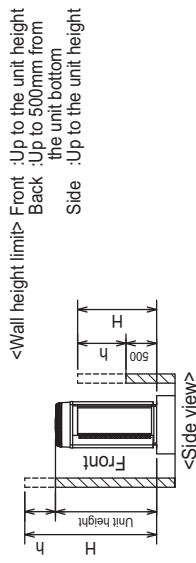

2. Foundation work

- Take into consideration the surface strength, water drainage route, piping route, and wiring route when preparing the installation site.
 - Note that the drain water comes out of the unit during operation.
- Build the foundation in such way that the corner of the installation leg is securely supported as shown in the right figure. (Fig.A, B)
 - When using a rubber isolating cushion, please ensure it is large enough to cover the entire width of each of the unit's legs.
- The protrusion length of the anchor bolt must not exceed 30mm. (Fig.A, B)
- Use four fixing plates as shown in the right figure <field supply required> when using post-installed anchor bolts. (Fig.C, D)
 - To prevent small animals and water and snow from entering the unit and damaging its parts, close the gap around the edges of through holes for pipes and wires with filler plates <field supply required>.
- When the pipes or cables are routed at the bottom of the unit, make sure that the through hole at the base of the unit does not get blocked with the installation base.
- Refer to the Installation Manual when installing units on an installation base.

● In case of collective installation

- When multiple units are installed adjacent to each other, secure enough space to allow for air circulation and walkway between groups of units as shown in the figures below.
- At least two sides must be left open.
- As with the single installation, add the height that exceeds the height limit <h> to the figures that are marked with an asterisk.
- If there is a wall at both the front and therear of the unit, install up to six units consecutively in the side direction and provide a space of 1000mm or more as inlet space/ passage space for each six units.

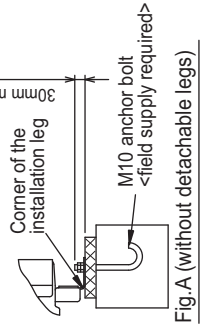
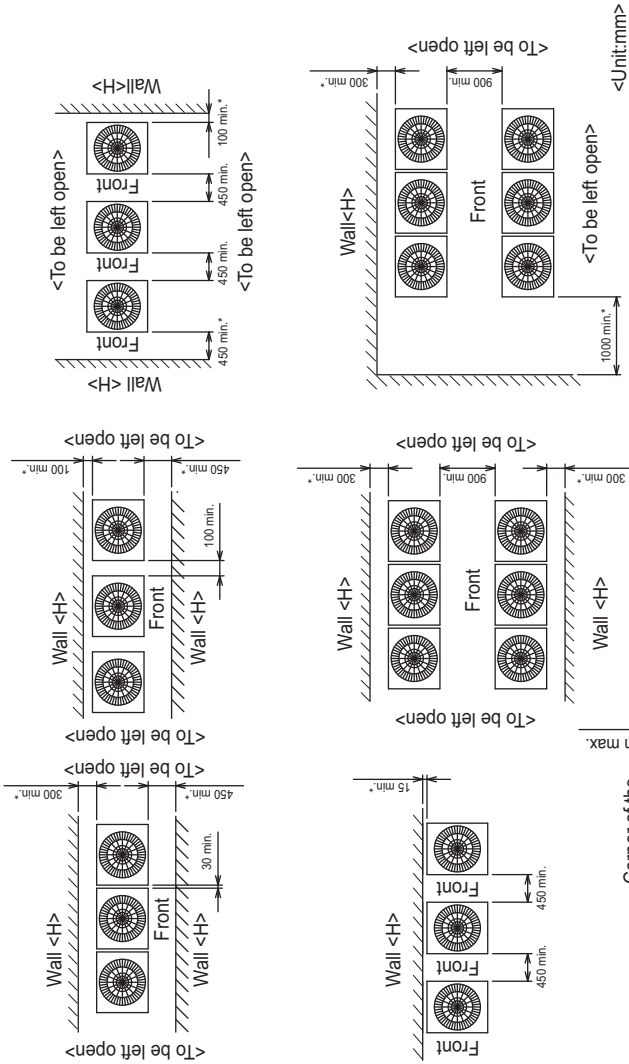

Fig.A (without detachable legs)

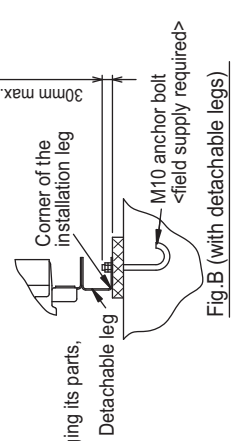

Fig.B (with detachable legs)

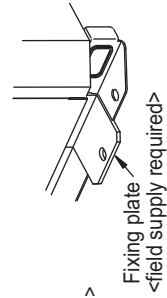

Fig.C (without detachable legs)

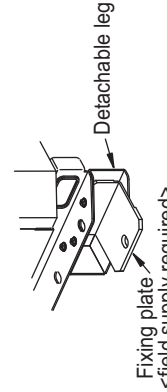
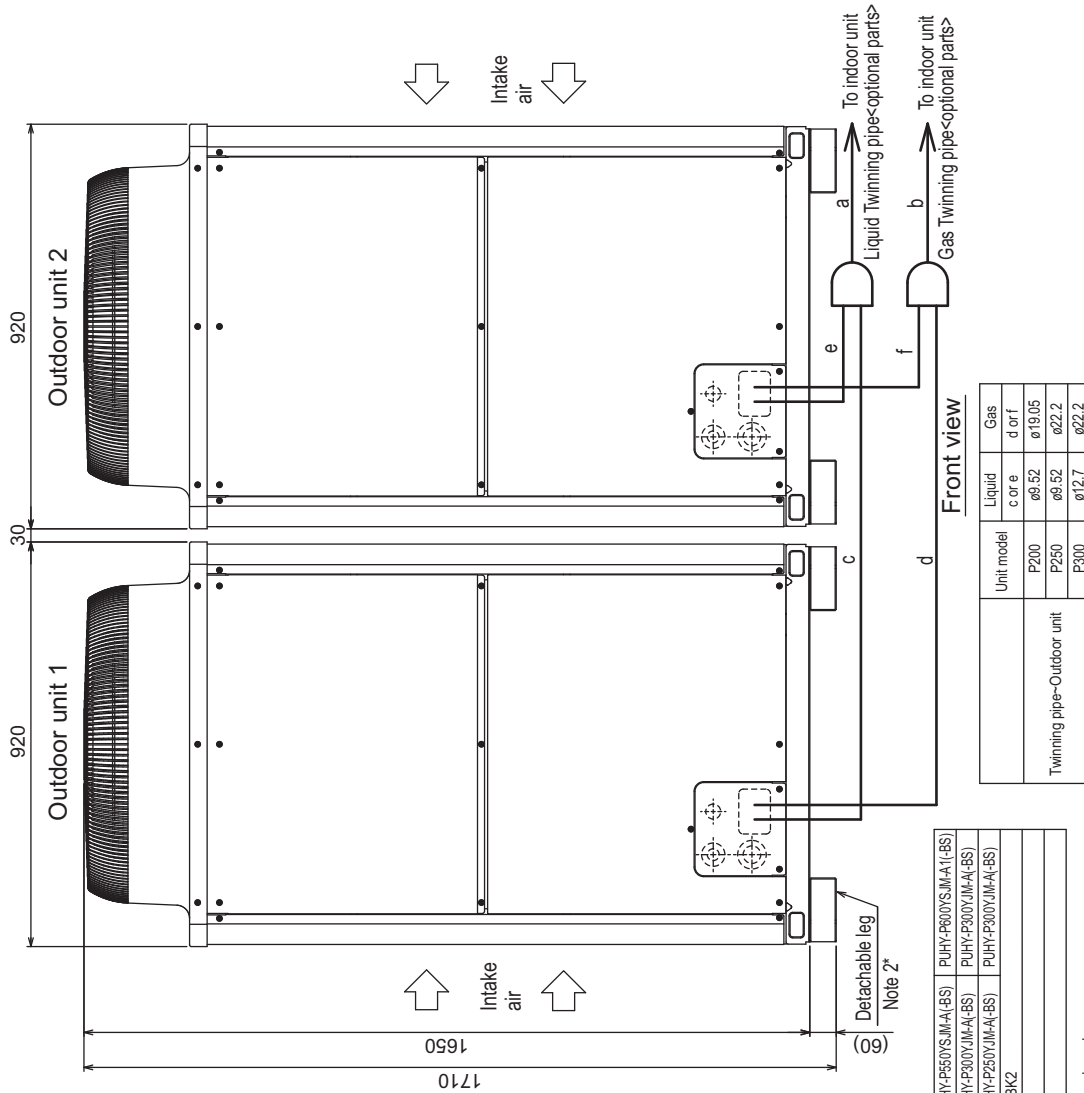

Fig.D (with detachable legs)

PUHY-P500,550,600YSJM-A(1)-(BS)

Unit : mm



Front view

Unit model	Liquid		Gas	
	c or e	d or f	ø19.05	ø22.2
P200	ø9.52	ø19.05	ø19.05	ø22.2
P250	ø9.52	ø22.2	ø22.2	ø22.2
P300	ø12.7	ø22.2	ø22.2	ø22.2

Twinning pipe-Outdoor unit

Twinning pipe connection size

Package unit name	PUHY-P500YSJM-A(1)-(BS)	PUHY-P550YSJM-A(1)-(BS)	PUHY-P600YSJM-A(1)-(BS)
Outdoor unit 1	PUHY-P500YSJM-A(1)-(BS)	PUHY-P550YSJM-A(1)-(BS)	PUHY-P600YSJM-A(1)-(BS)
Outdoor unit 2	PUHY-P200YSJM-A(1)-(BS)	PUHY-P250YSJM-A(1)-(BS)	PUHY-P300YSJM-A(1)-(BS)
Outdoor Twinning Kit(optional parts)	PUHY-P200YSJM-A(1)-(BS)	PUHY-P250YSJM-A(1)-(BS)	PUHY-P300YSJM-A(1)-(BS)
Indoor unit-Twinning pipe	CMY-Y100YBK2		
	a	ø15.88	
b	ø28.58		

- Note 1. Connect the pipes as shown in the figure above. Refer to the table above for the pipe size.
2. The detachable leg can be removed at site.
3. Twinning pipes should not be tilted more than 15 degrees from the horizontal plane. Be sure to see the Installation Manual for details of Twinning pipe installation.
4. The pipe section before the Twinning pipe (sections "a" and "b" in the figure) must have at least 500mm of straight section (*including the straight pipe that is supplied with the Twinning pipe).
5. Only use the Twinning pipe by Mitsubishi (optional parts).

PUHY-P600,650,700YSJM-A(1)-(BS)

Unit : mm

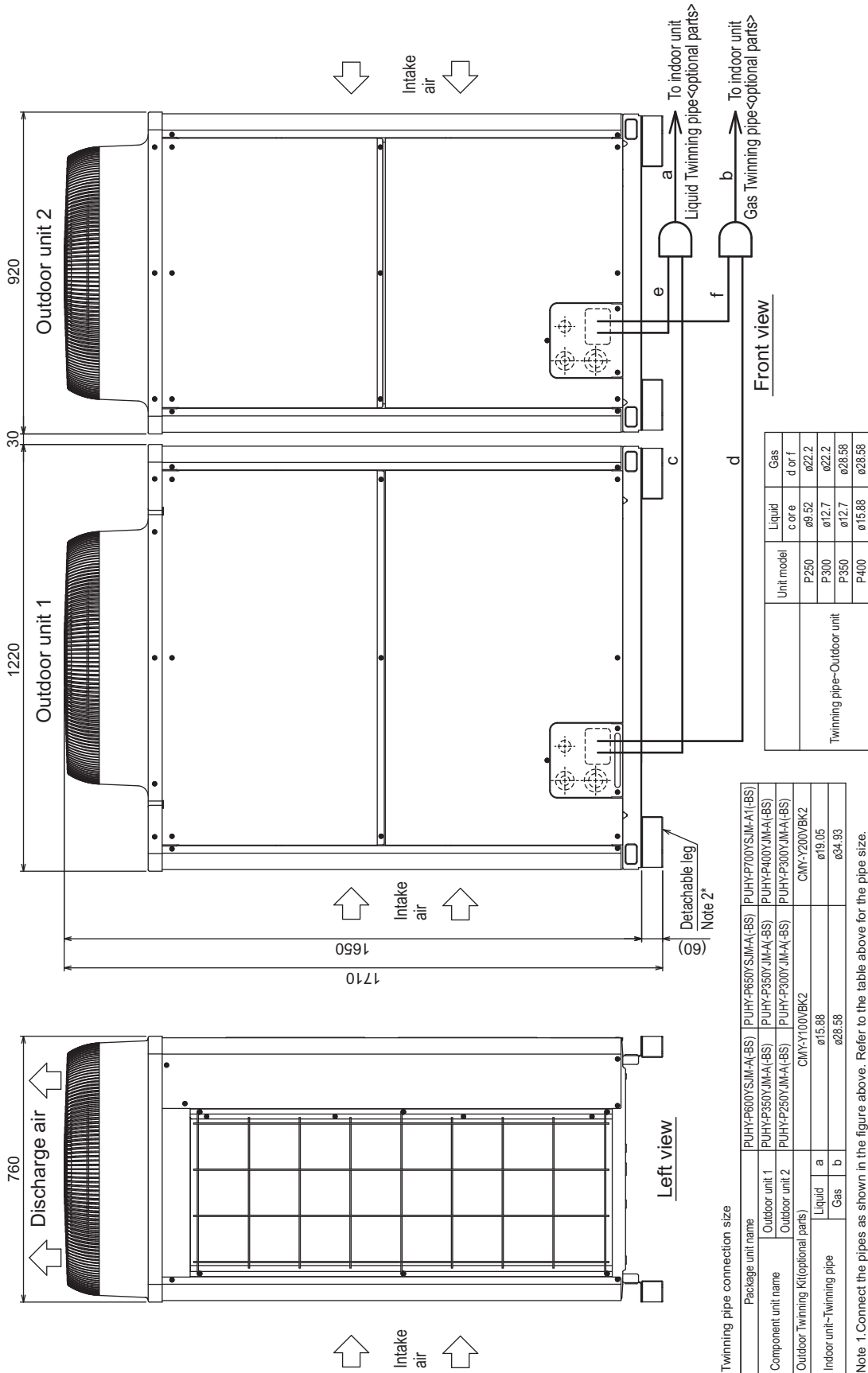

- Note 1. Connect the pipes as shown in the figure above. Refer to the table above for the pipe size.
2. The detachable leg can be removed at site.
3. Twinning pipes should not be tilted more than 15 degrees from the horizontal plane. Be sure to see the Installation Manual for details of Twinning pipe installation.
4. The pipe section before the Twinning pipe (sections "a" and "b" in the figure) must have at least 500mm of straight section (*including the straight pipe that is supplied with the Twinning pipe).
5. Only use the Twinning pipe by Mitsubishi (optional parts).

Y

PUHY-P700,750,800YSJM-A(1)-(BS)

Unit : mm

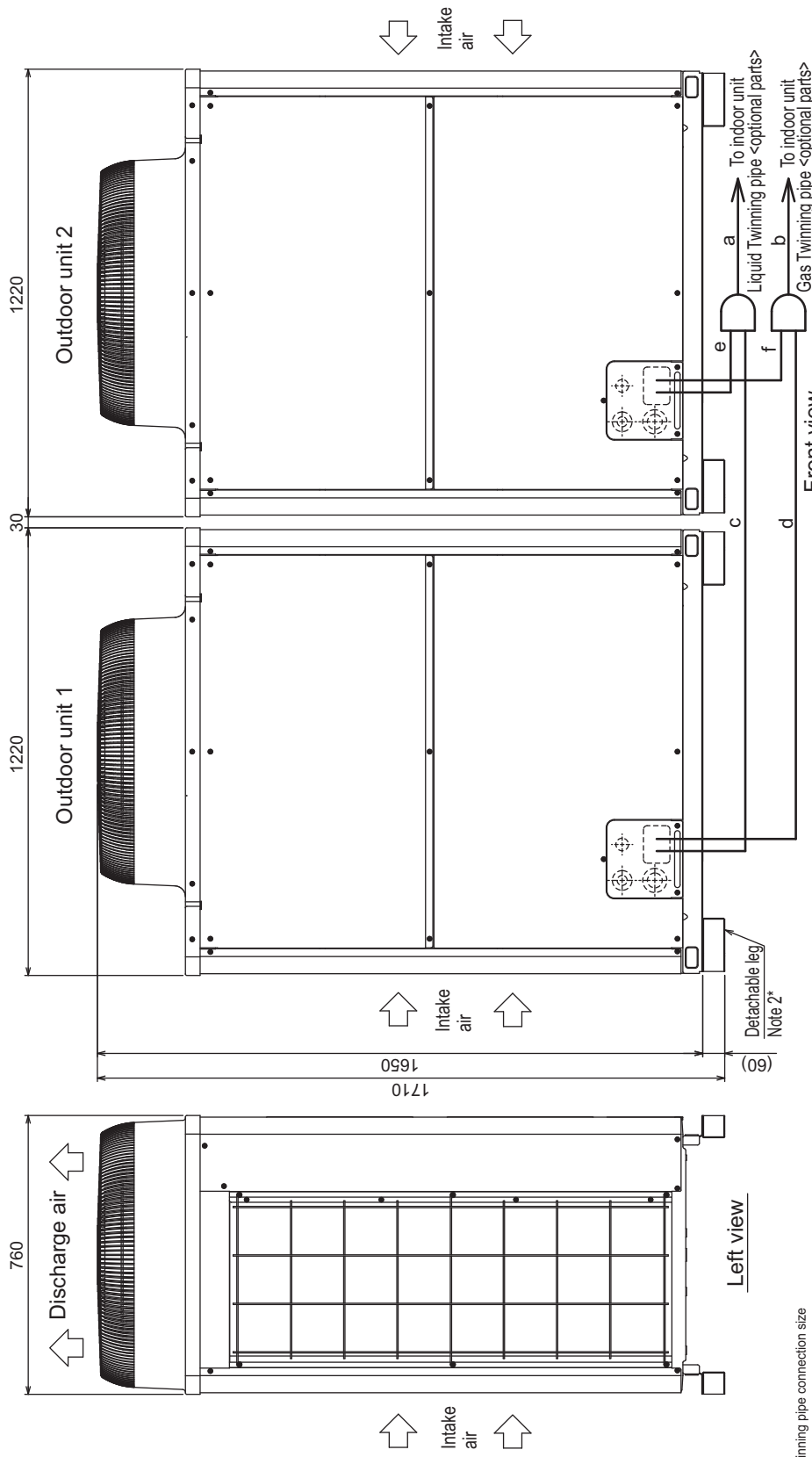

Front view

Twinning pipe connection size		PUHY-P700YSJM-A(-BS)	PUHY-P750YSJM-A(-BS)	PUHY-P800YSJM-A(-BS)
Package unit name		PUHY-P700YSJM-A(-BS)	PUHY-P750YSJM-A(-BS)	PUHY-P800YSJM-A(-BS)
Component unit name		PUHY-P350YSJM-A(-BS)	PUHY-P400YSJM-A(-BS)	PUHY-P400YSJM-A(-BS)
Outdoor unit name		PUHY-P350YSJM-A(-BS)	PUHY-P350YSJM-A(-BS)	PUHY-P400YSJM-A(-BS)
Outdoor Twinning Kit(optional parts)		CMY-Y200VBK2		
Indoor unit~Twinning pipe		ø19.05		
		ø34.93		
		ø15.88		
		ø28.58		

Twinning pipe-Outdoor unit	Unit model	Liquid core	Gas d or f
	P350	ø12.7	ø28.58
	P400	ø15.88	ø28.58

- Note 1. Connect the pipes as shown in the figure above. Refer to the table above for the pipe size.
2. The detachable leg can be removed at site.
3. Twinning pipes should not be tilted more than 15 degrees from the horizontal plane.
- Be sure to see the Installation Manual for details of Twinning pipe installation.
4. The pipe section before the Twinning pipe (sections "a" and "b" in the figure) must have at least 500mm of straight section (*including the straight pipe that is supplied with the Twinning pipe).
5. Only use the Twinning pipe by Mitsubishi (optional parts).

PUHY-P800,850YSJM-A(-BS)

Unit : mm

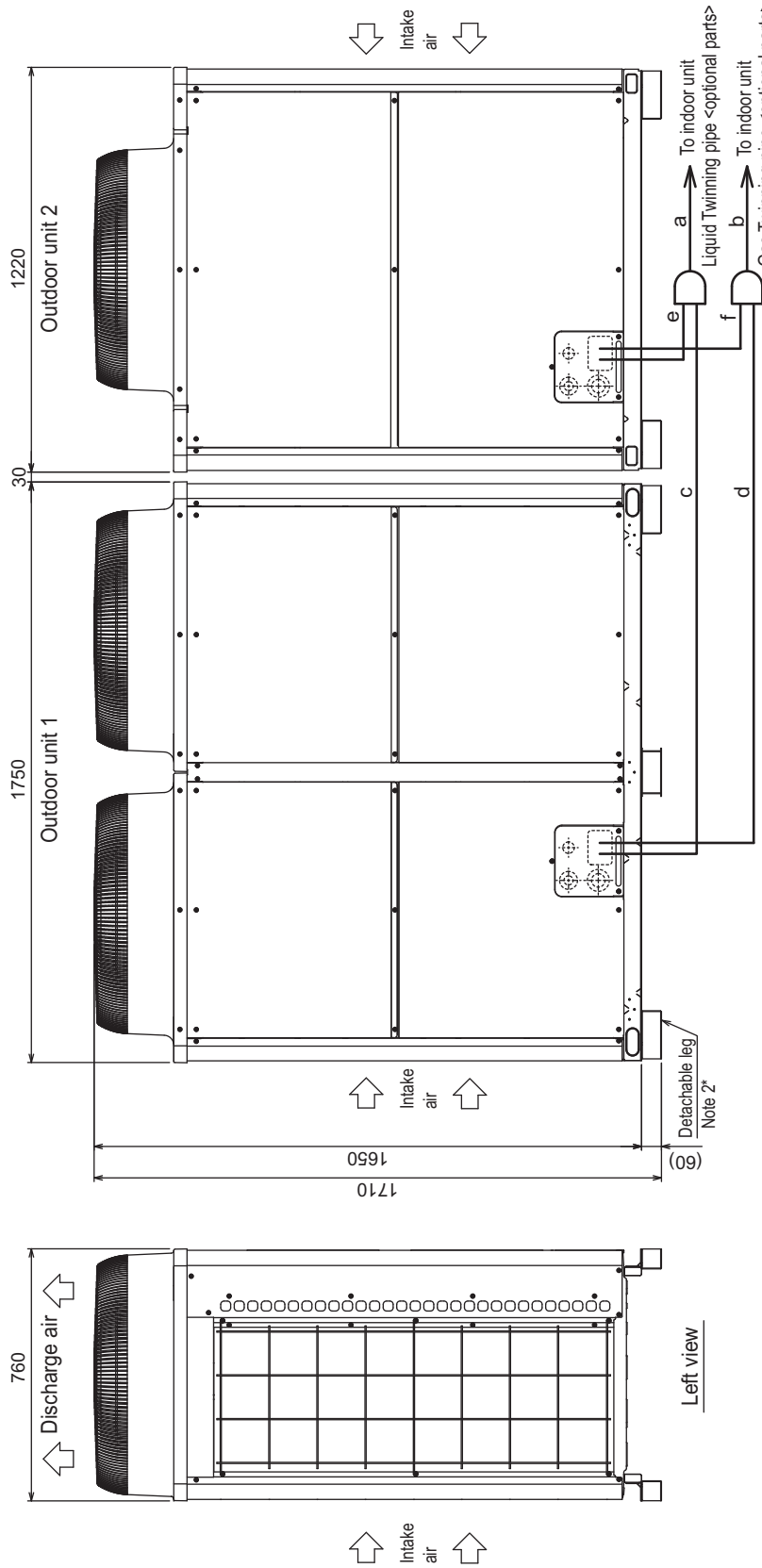

Front view

Left view

Twinning pipe connection size

Package unit name	PUHY-P800YSJM-A(-BS)	PUHY-P850YSJM-A(-BS)	PUHY-P450YSJM-A(-BS)	PUHY-P450YJM-A(-BS)
Outdoor unit 1	PUHY-P350YJM-A(-BS)	PUHY-P400YJM-A(-BS)	PUHY-P400YJM-A(-BS)	PUHY-P400YJM-A(-BS)
Outdoor unit 2	PUHY-P350YJM-A(-BS)	PUHY-P400YJM-A(-BS)	PUHY-P400YJM-A(-BS)	PUHY-P400YJM-A(-BS)
Outdoor Twinning Kit (optional parts)	CMY-Y200VBK2			
Indoor unit-Twinning pipe	Liquid	a	ø19.05	
	Gas	b	ø34.93	ø41.28

Twinning pipe-Outdoor unit	Unit model		Gas d or f
	Liquid c or e	Gas	
P350	ø12.7	ø28.58	
	ø15.88	ø28.58	
P400	ø15.88	ø28.58	
P450	ø15.88	ø28.58	

Note 1. Connect the pipes as shown in the figure above. Refer to the table above for the pipe size.

2. The detachable leg can be removed at site.

3. Twinning pipes should not be tilted more than 15 degrees from the horizontal plane.

Be sure to see the Installation Manual for details of Twinning pipe installation.

4. The pipe section before the Twinning pipe (sections "a" and "b" in the figure) must have at least 500mm of straight section

(*including the straight pipe that is supplied with the Twinning pipe).

5. Only use the Twinning pipe by Mitsubishi (optional parts).

PUHY-P900YSJM-A(-BS)

Unit : mm

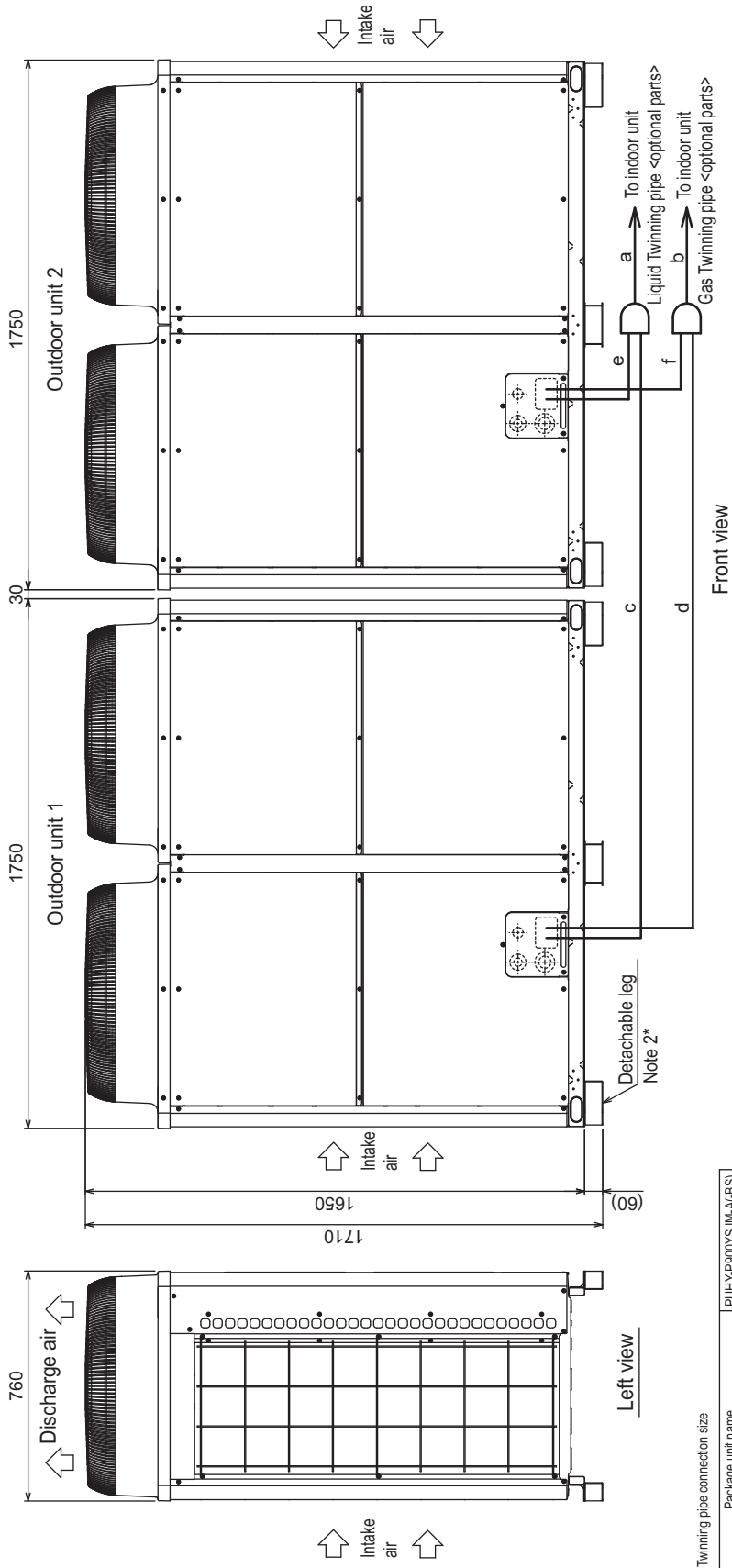

Twinning pipe connection size

Package unit name	PUHY-P900YSJM-A(-BS)	
Outdoor unit 1	PUHY-P450YSJM-A(-BS)	
Outdoor unit 2	PUHY-P450YSJM-A(-BS)	
Outdoor Twinning Kit (optional parts)	CMY-Y20VBK2	
Indoor unit-Twinning pipe	Liquid	a
	Gas	b
		ø19.05
		ø41.28

Unit model	Liquid	Gas
P450	c or e	d or f
Twinning pipe-Outdoor unit	ø15.88	ø28.58

- Note 1. Connect the pipes as shown in the figure above. Refer to the table above for the pipe size.
- 2. The detachable leg can be removed at site.
- 3. Twinning pipes should not be tilted more than 15 degrees from the horizontal plane. Be sure to see the Installation Manual for details of Twinning pipe installation.
- 4. The pipe section before the "twinning pipe (sections "a" and "b" in the figure) must have at least 500mm of straight section (*including the straight pipe that is supplied with the Twinning pipe).
- 5. Only use the "twinning pipe by Mitsubishi" (optional parts).

PUHY-P950,1000YSJM-A(-BS)

Unit : mm

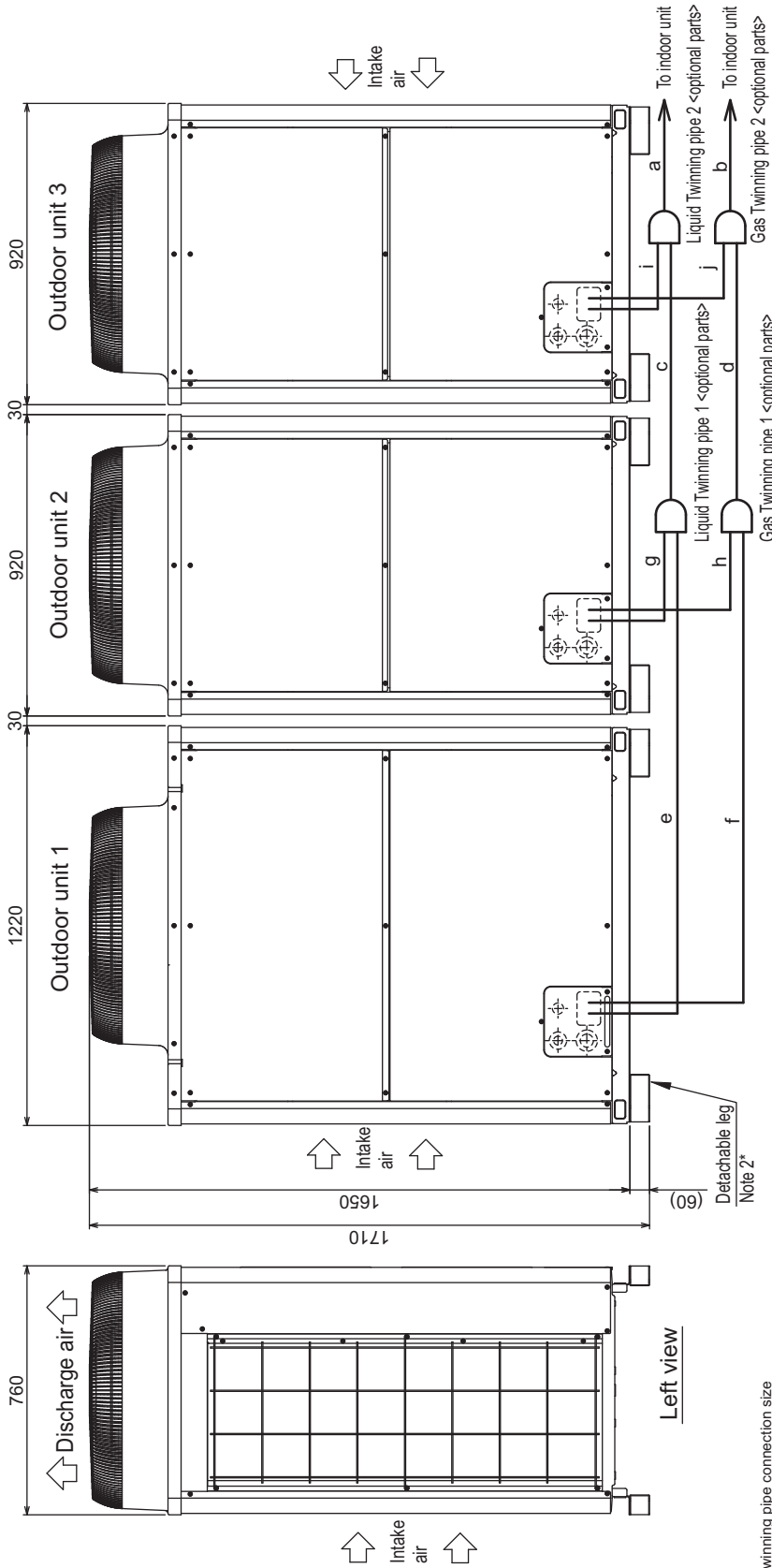

Front view

Left view

Twinning pipe connection size

Package unit name	PUHY-P950YSJM-A(-BS)	PUHY-P1000YSJM-A(-BS)
Outdoor unit 1	PUHY-P400YJM-A(-BS)	PUHY-P400YJM-A(-BS)
Outdoor unit 2	PUHY-P300YJM-A(-BS)	PUHY-P300YJM-A(-BS)
Outdoor unit 3	PUHY-P250YJM-A(-BS)	PUHY-P300YJM-A(-BS)
Outdoor Twinning Kit(optional parts)	CMY-Y300VBK2	
Liquid a	ø19.05	
Gas b	ø41.28	
Liquid c	ø19.05	
Gas d	ø34.93	

Unit model	Liquid	Gas
P250	e or g or i	f or h or j
P300	ø9.52	ø22.2
P400	ø12.7	ø28.58

Note 1. Connect the pipes as shown in the figure above. Refer to the table above for the pipe size.

2. The detachable leg can be removed at site.

3. Twinning pipes should not be tilted more than 15 degrees from the horizontal plane.

Be sure to see the Installation Manual for details of Twinning pipe installation.

4. The pipe section before the Twinning pipe (sections "a", "b", "c" and "d" in the figure) must have at least 500mm of straight section

(*including the straight pipe that is supplied with the Twinning pipe).

5. Only use the Twinning pipe by Mitsubishi (optional parts).

PUHY-P1050YSJM-A(-BS)

Unit : mm

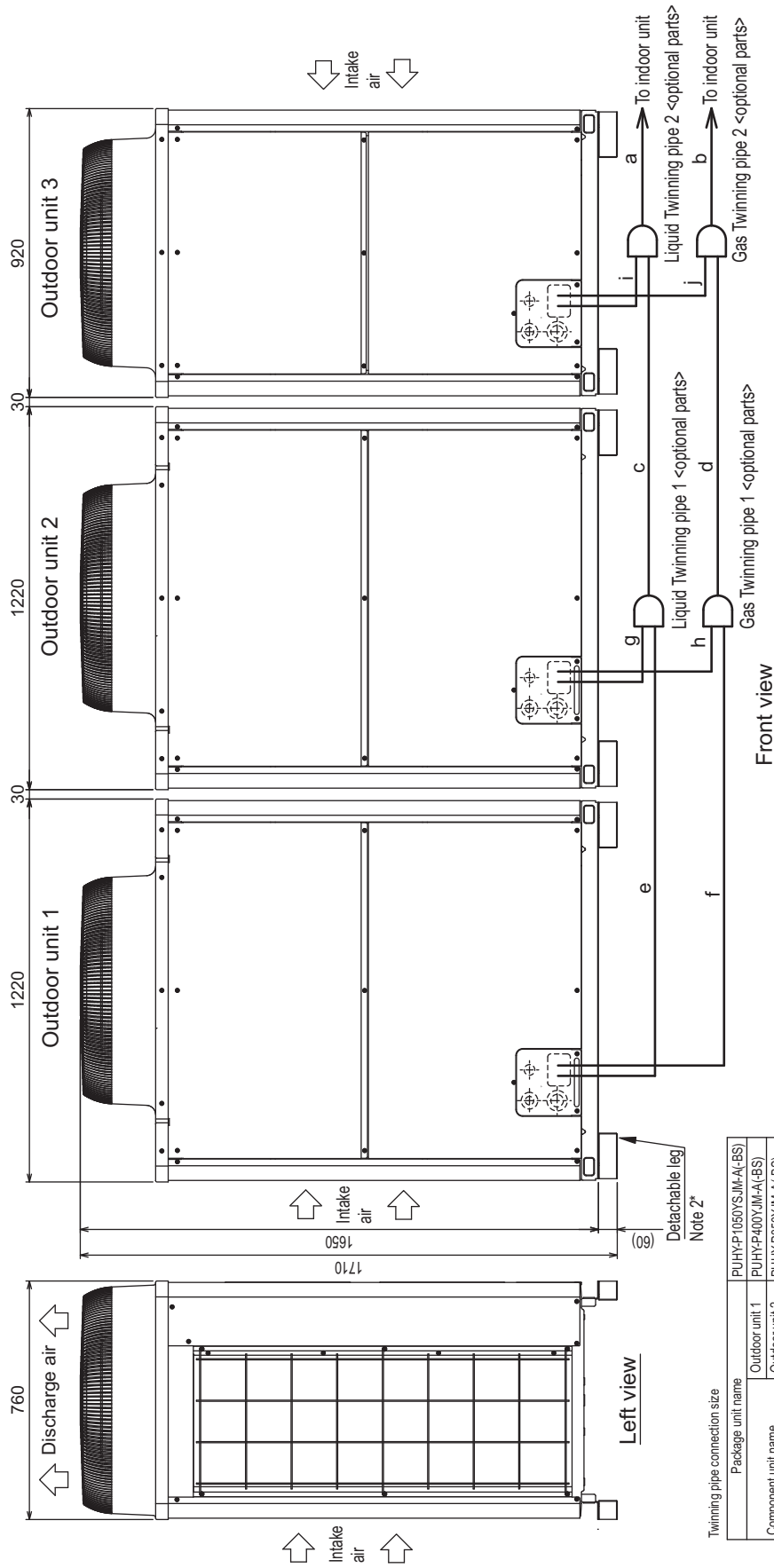

Unit model	Liquid e or g ori	Gas f or h ori
P300	ø12.7	ø22.2
P350	ø12.7	ø28.58
P400	ø15.88	ø28.58

Twinning pipe-Outdoor unit

Package unit name	PUHY-P1050YSJM-A(-BS)	
Outdoor unit 1	PUHY-P400YJM-A(-BS)	
Outdoor unit 2	PUHY-P350YJM-A(-BS)	
Outdoor unit 3	PUHY-P300YJM-A(-BS)	
Outdoor Twinning Kit(optional parts)	CMY-Y300VBK2	
Indoor unit-Twinning pipe 2	Liquid a	ø19.05
	Gas b	ø41.28
Twinning pipe 1-Twinning pipe 2	Liquid c	ø19.05
	Gas d	ø34.93

- Note 1. Connect the pipes as shown in the figure above. Refer to the table above for the pipe size.
2. The detachable leg can be removed at site.
3. Twinning pipes should not be tilted more than 15 degrees from the horizontal plane. Be sure to see the installation Manual for details of Twinning pipe installation.
4. The pipe section before the Twinning pipe (sections "a", "b", "c" and "d" in the figure) must have at least 500mm of straight section (*including the straight pipe that is supplied with the Twinning pipe).
5. Only use the Twinning pipe by Mitsubishi (optional parts).

PUHY-P1100YSJM-A(-BS)

Unit : mm

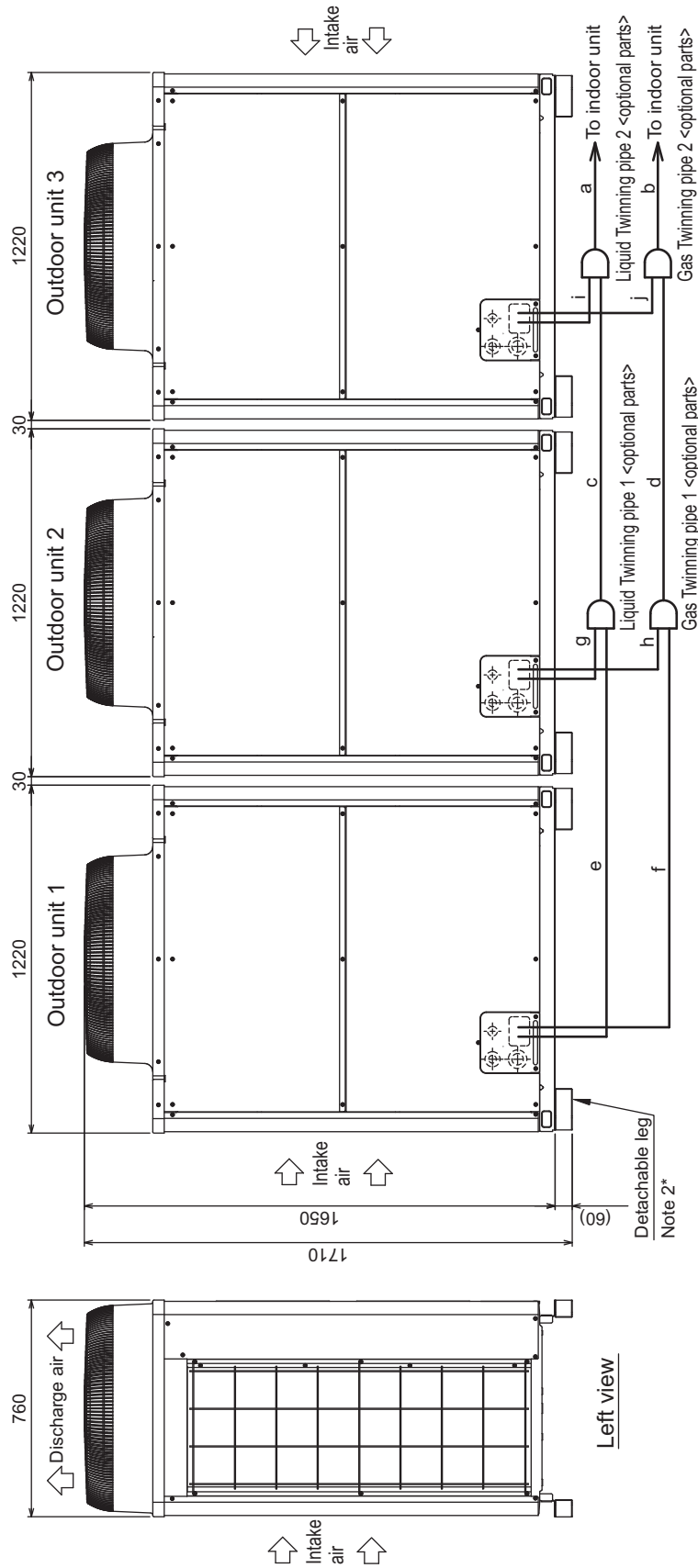

Front view

Left view

Twinning pipe connection size

Package unit name	PUHY-P1100YSJM-A(-BS)	
Component unit name	Outdoor unit 1 Outdoor unit 2 Outdoor unit 3	
Outdoor Twinning Kit (optional parts)	CMY-Y300VBK2	
Indoor unit~Twinning pipe 2	Liquid a	ø19.05
	Gas b	ø41.28
Twinning pipe 1~Twinning pipe 2	Liquid c	ø19.05
	Gas d	ø34.93

Unit model	Liquid e or f or i	Gas
Twinning pipe~Outdoor unit	P350	ø12.7
	P400	ø15.88
		ø28.58

Note 1. Connect the pipes as shown in the figure above. Refer to the table above for the pipe size.

2. The detachable leg can be removed at site.

3. Twinning pipes should not be tilted more than 15 degrees from the horizontal plane.

Be sure to see the Installation Manual for details of Twinning pipe installation.

4. The pipe section before the Twinning pipe (sections "a", "b", "c" and "d" in the figure) must have at least 500mm of straight section

(*including the straight pipe that is supplied with the Twinning pipe).

5. Only use the Twinning pipe by Mitsubishi (optional parts).

PUHY-P1150,1200YSJM-A(-BS)

Unit : mm

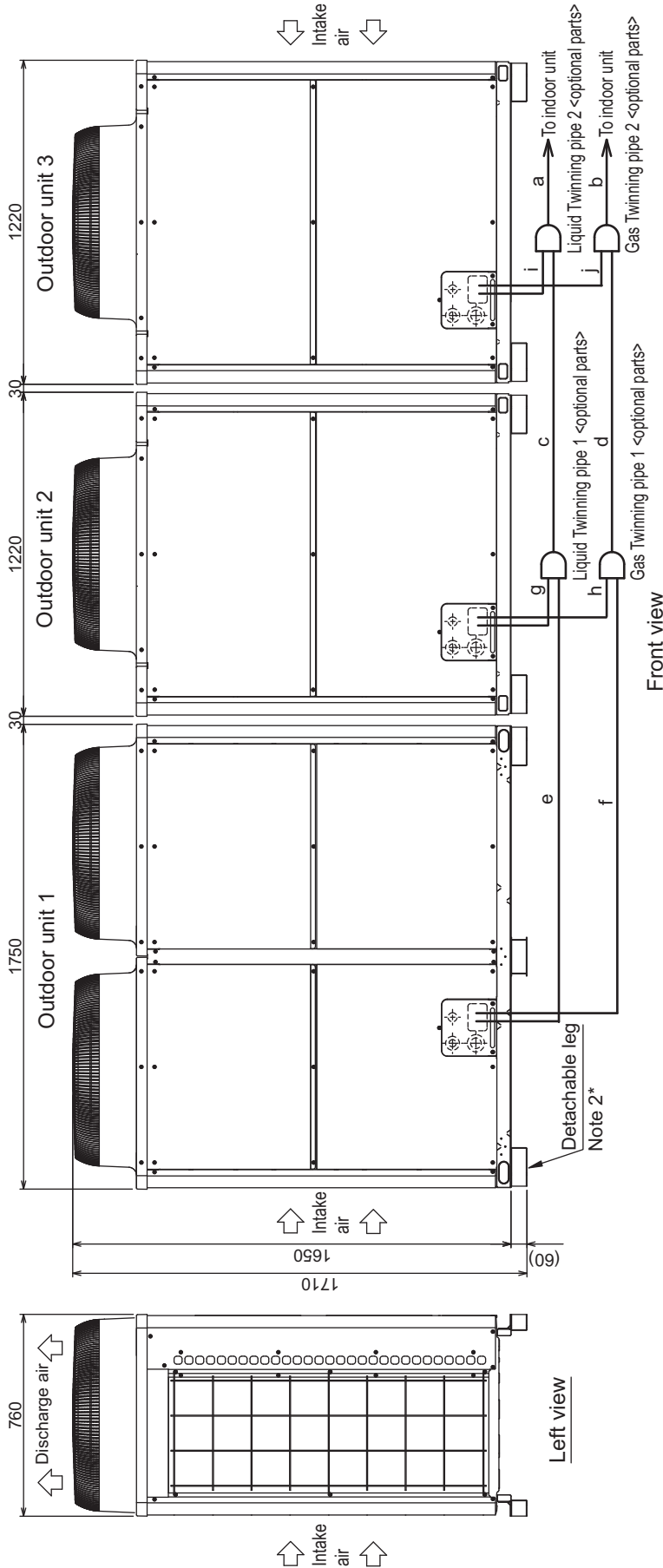

Front view

Left view

Twinning pipe connection size

Package unit name	PUHY-P1150YSJM-A(-BS)	PUHY-P1200YSJM-A(-BS)
Outdoor unit 1	PUHY-P450YJM-A(-BS)	PUHY-P450YJM-A(-BS)
Outdoor unit 2	PUHY-P350YJM-A(-BS)	PUHY-P400YJM-A(-BS)
Outdoor unit 3	PUHY-P350YJM-A(-BS)	PUHY-P350YJM-A(-BS)
Outdoor Twinning Kit(optional parts)	CMY-Y300VBK2	
Indoor unit- Twinning pipe 2	Liquid a	ø19.05
	Gas b	ø41.28
Twinning pipe 1- Twinning pipe 2	Liquid c	ø19.05
	Gas d	ø34.93

Unit model	Liquid e or g or i	Gas f or h or j
P350	ø12.7	ø28.58
P400	ø15.88	ø28.58
P450	ø15.88	ø28.58

Twinning pipe-Outdoor unit

- Note 1. Connect the pipes as shown in the figure above. Refer to the table above for the pipe size.
 2. The detachable leg can be removed at site.
 3. Twinning pipes should not be tilted more than 15 degrees from the horizontal plane.
 Be sure to see the Installation Manual for details of Twinning pipe installation.
 4. The pipe section before the Twinning pipe (sections "a", "b", "c" and "d" in the figure) must have at least 500mm of straight section (*including the straight pipe that is supplied with the Twinning pipe).
 5. Only use the Twinning pipe by Mitsubishi (optional parts).

3. CENTER OF GRAVITY

PUHY-P200, P250, P300, EP200YJM-A (-BS)

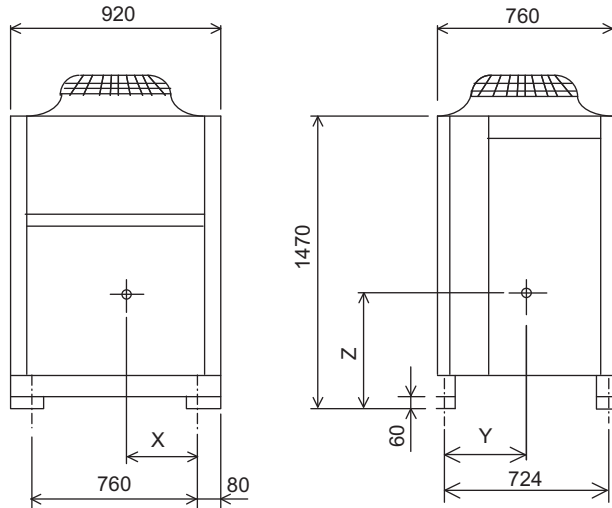

Unit:mm

Model	X	Y	Z
PUHY-P200YJM-A (-BS)	330	309	647
PUHY-P250YJM-A (-BS)	334	329	652
PUHY-P300YJM-A (-BS)	320	319	632
PUHY-EP200YJM-A (-BS)	334	329	652

PUHY-P350, P400, EP250YJM-A (-BS)

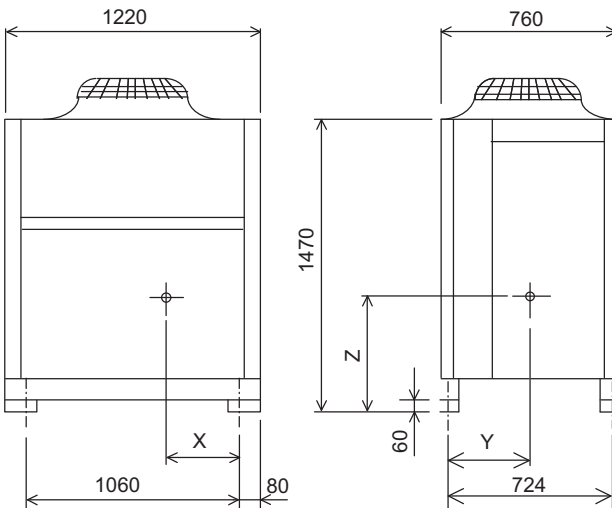

Unit:mm

Model	X	Y	Z
PUHY-P350YJM-A (-BS)	440	329	630
PUHY-P400YJM-A (-BS)	440	329	630
PUHY-EP250YJM-A (-BS)	440	329	630

PUHY-P450, EP300YJM-A (-BS)

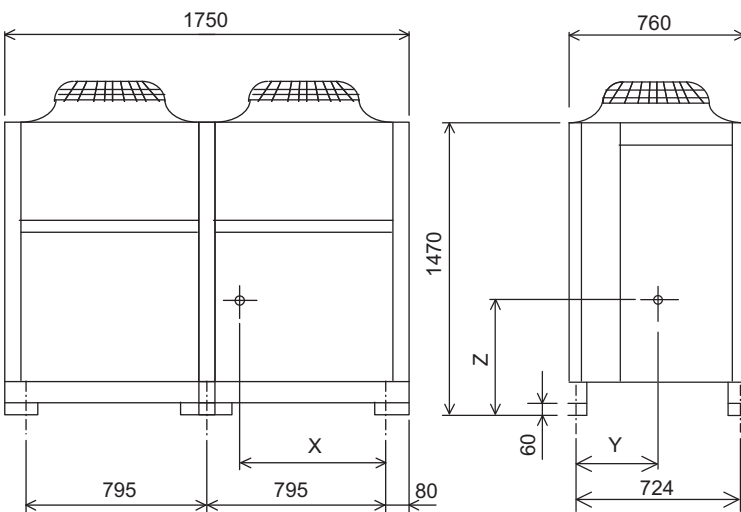

Unit:mm

Model	X	Y	Z
PUHY-P450YJM-A (-BS)	705	310	720
PUHY-EP300YJM-A (-BS)	705	310	720

PUHY-P450YJM-A(-BS) PUHY-EP300YJM-A(-BS)

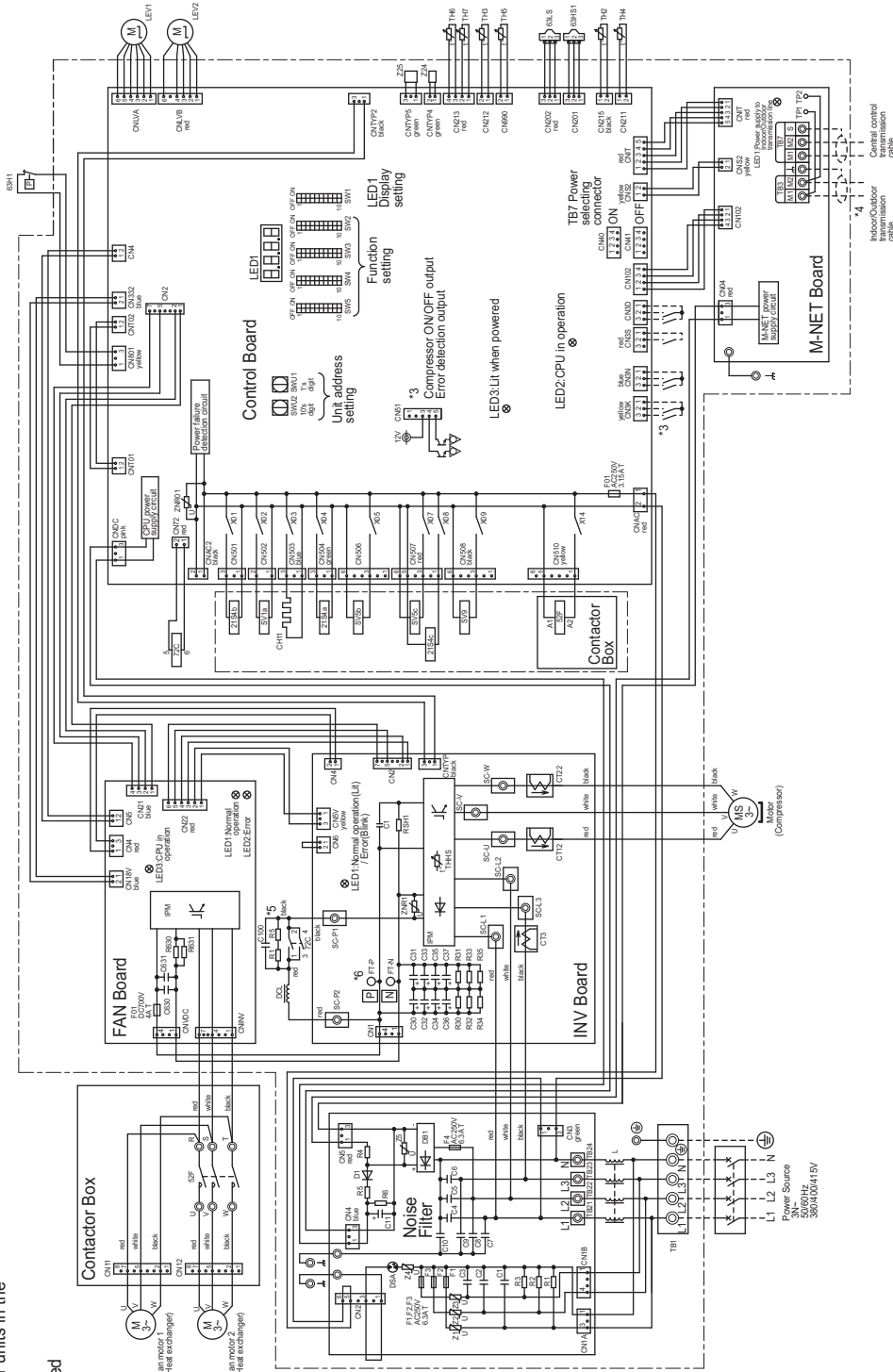

- *1. Single-dotted lines indicate wiring not supplied with the unit.
- *2. Dot-dash lines indicate the control box boundaries.
- *3. Refer to the Data book for connecting input/output signal connectors.
- *4. Daisy-chain terminals (TB3) on the outdoor units in the same refrigerant system together.
- *5. Faston terminals have a locking function. Make sure the terminals are securely locked in place after insertion. Press the tab on the terminals to remove them.
- *6. Control box houses high-voltage parts. Before inspecting the inside of the control box, turn off the power, keep the unit off for at least 10 minutes, and confirm that the voltage between FT-P and FT-N on INV Board has dropped to DC20V or less.

<Symbol explanation>

Symbol	Explanation
21S4a	Cooling/Heating switching
21S4b.c	Heat exchanger capacity control
5ZF	Magnetic contactor(FAN)
63H1	Pressure switch
63HS1	Pressure sensor
63LS	Low pressure
Z7C	Magnetic relay(inverter main circuit)
CT12, 22, 3	Current sensor(AC)
CH11	Crankcase heater(for heating the compressor)
DCL	DC reactor
LEV1	Linear expansion valve
LEV2	Solenoid valve
SV1a	Pressure control/Refrigerant flow rate control
SV5b.c	For opening/closing the bypass circuit under the O/S capacity control
SV9	For opening/closing the bypass capacity control
TB3	Terminal block
TB7	Terminal block
TH2	Thermistor
TH3	Subcool bypass outlet temperature
TH4	Pipe temperature
TH5	Discharge pipe temperature
TH6	ACC inlet pipe temperature
TH7	Subcooled liquid refrigerant temperature
THHS	OA temperature
Z24, 25	IPM temperature
	Function setting connector

Y

Measurement condition
PUHY-P200,250,300YJM-A(-BS)

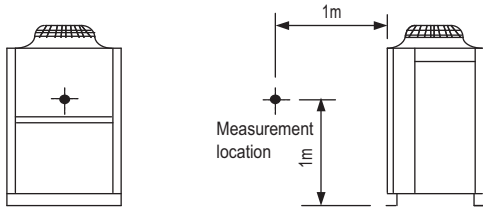

Sound level of PUHY-P300YJM-A(-BS)

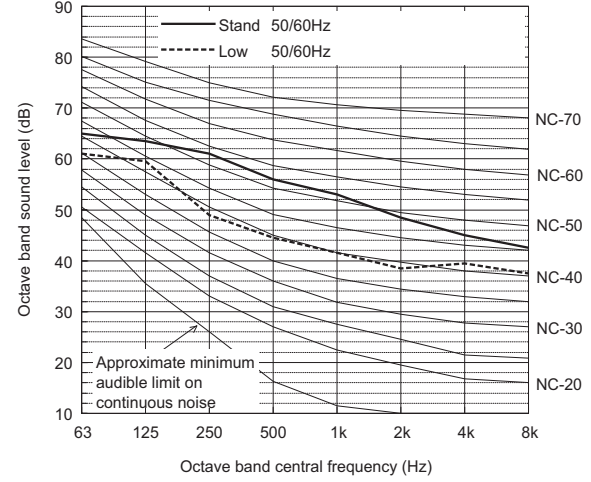

		63	125	250	500	1k	2k	4k	8k	dB(A)
Standard	50/60Hz	65.0	63.5	61.0	56.0	53.0	48.5	45.0	42.5	59.0
Low noise mode	50/60Hz	61.0	59.5	49.0	44.5	41.5	38.5	39.5	37.5	50.0

When Low noise mode is set, the A/C system's capacity is limited. The system could return to normal operation from Low noise mode automatically in the case that the operation condition is severe.

Sound level of PUHY-P200YJM-A(-BS)

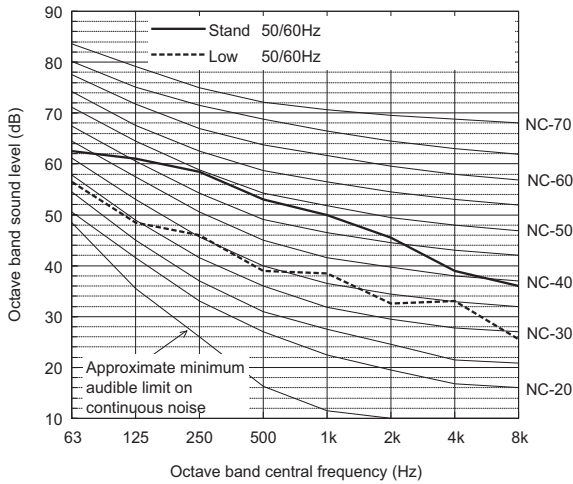

		63	125	250	500	1k	2k	4k	8k	dB(A)
Standard	50/60Hz	62.5	61.0	58.5	53.0	50.0	45.5	39.0	36.0	56.0
Low noise mode	50/60Hz	56.5	48.5	46.0	39.0	38.5	32.5	33.0	25.5	44.0

When Low noise mode is set, the A/C system's capacity is limited. The system could return to normal operation from Low noise mode automatically in the case that the operation condition is severe.

Sound level of PUHY-P250YJM-A(-BS)

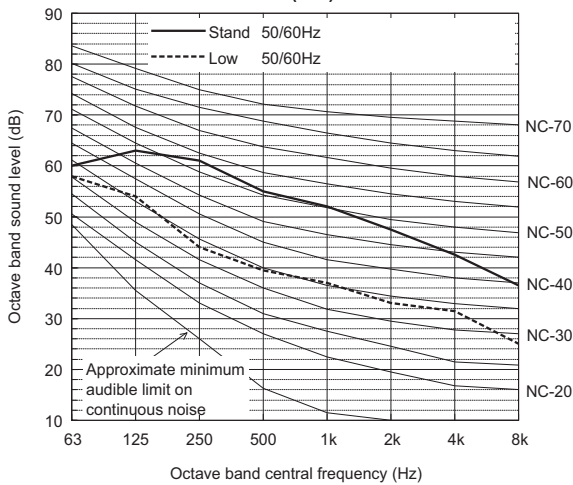

		63	125	250	500	1k	2k	4k	8k	dB(A)
Standard	50/60Hz	60.0	63.0	61.0	55.0	52.0	47.5	42.5	36.5	58.0
Low noise mode	50/60Hz	58.0	54.0	44.0	39.5	37.0	33.0	31.5	25.0	44.0

When Low noise mode is set, the A/C system's capacity is limited. The system could return to normal operation from Low noise mode automatically in the case that the operation condition is severe.

Measurement condition
PUHY-P350,400YJM-A(-BS)

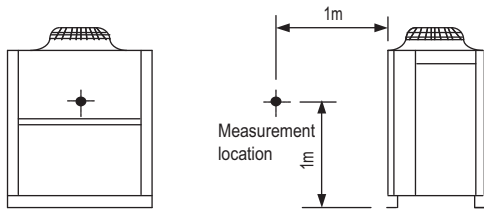

Measurement condition
PUHY-P450YJM-A(-BS)

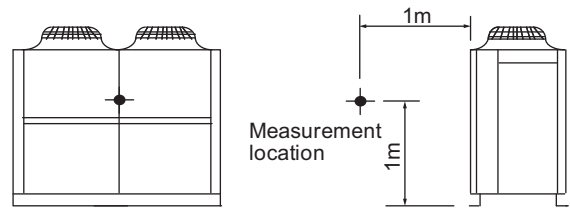

Sound level of PUHY-P350YJM-A(-BS)

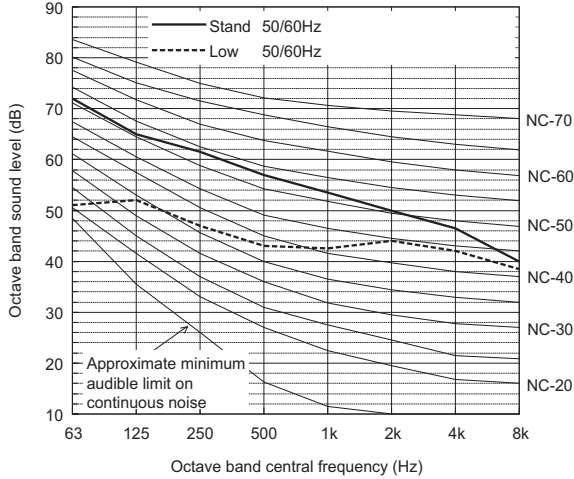

		63	125	250	500	1k	2k	4k	8k	dB(A)
Standard	50/60Hz	72.0	65.0	61.5	57.0	53.5	50.0	46.5	40.0	60.0
Low noise mode	50/60Hz	51.0	52.0	47.0	43.0	42.5	44.0	42.0	38.5	50.0

When Low noise mode is set, the A/C system's capacity is limited. The system could return to normal operation from Low noise mode automatically in the case that the operation condition is severe.

Sound level of PUHY-P450YJM-A(-BS)

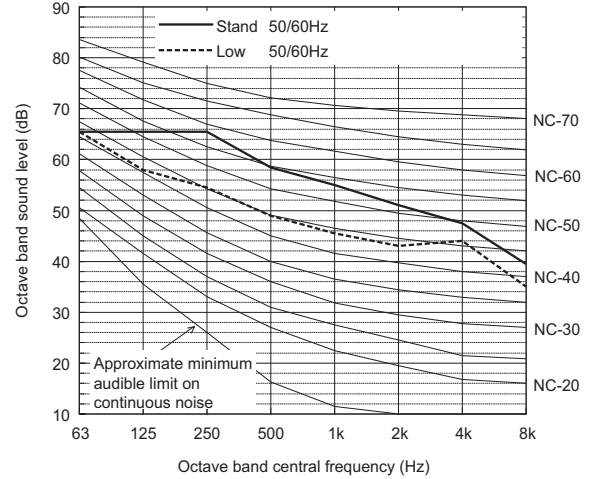

		63	125	250	500	1k	2k	4k	8k	dB(A)
Standard	50/60Hz	65.5	65.5	65.5	58.5	55.0	51.0	47.5	39.5	62.0
Low noise mode	50/60Hz	65.5	58.0	54.5	49.0	45.5	43.0	44.0	35.0	53.0

When Low noise mode is set, the A/C system's capacity is limited. The system could return to normal operation from Low noise mode automatically in the case that the operation condition is severe.

Sound level of PUHY-P400YJM-A(-BS)

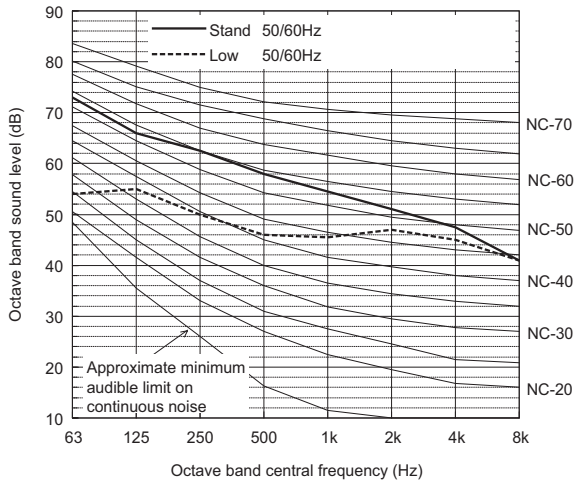

		63	125	250	500	1k	2k	4k	8k	dB(A)
Standard	50/60Hz	73.0	66.0	62.5	58.0	54.5	51.0	47.5	41.0	61.0
Low noise mode	50/60Hz	54.0	55.0	50.0	46.0	45.5	47.0	45.0	41.0	53.0

When Low noise mode is set, the A/C system's capacity is limited. The system could return to normal operation from Low noise mode automatically in the case that the operation condition is severe.

Y

Measurement condition
PUHY-P500,550,600YSJM-A(1)(-BS)

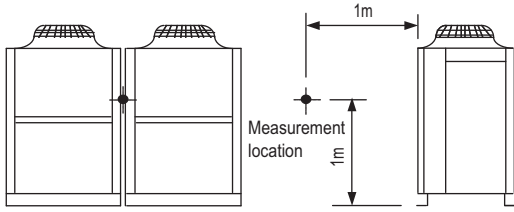

Sound level of PUHY-P550YSJM-A(-BS)

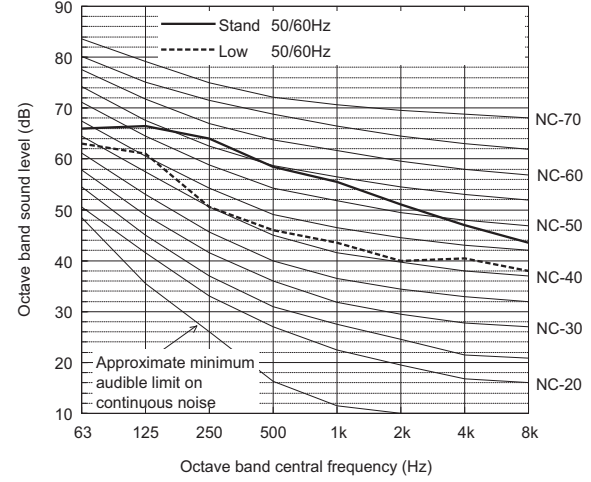

		63	125	250	500	1k	2k	4k	8k	dB(A)
Standard	50/60Hz	66.0	66.5	64.0	58.5	55.5	51.0	47.0	43.5	61.5
Low noise mode	50/60Hz	63.0	61.0	50.5	46.0	43.5	40.0	40.5	38.0	51.0

When Low noise mode is set, the A/C system's capacity is limited. The system could return to normal operation from Low noise mode automatically in the case that the operation condition is severe.

Sound level of PUHY-P500YSJM-A(-BS)

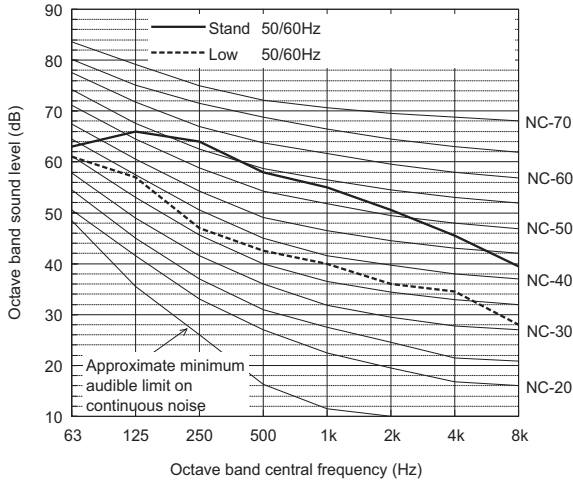

		63	125	250	500	1k	2k	4k	8k	dB(A)
Standard	50/60Hz	63.0	66.0	64.0	58.0	55.0	50.5	45.5	39.5	61.0
Low noise mode	50/60Hz	61.0	57.0	47.0	42.5	40.0	36.0	34.5	28.0	47.0

When Low noise mode is set, the A/C system's capacity is limited. The system could return to normal operation from Low noise mode automatically in the case that the operation condition is severe.

Sound level of PUHY-P600YSJM-A1(-BS)

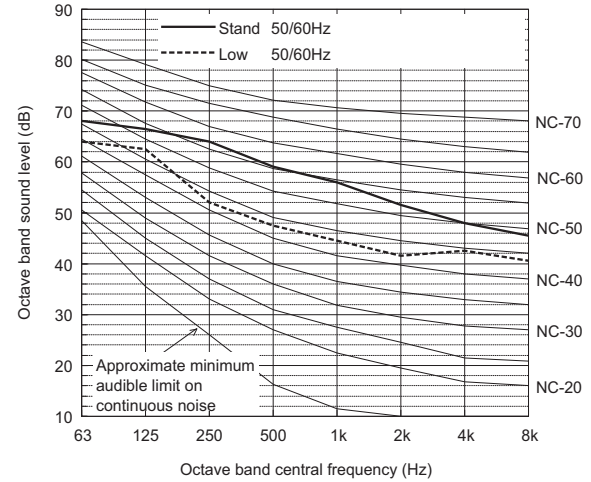

		63	125	250	500	1k	2k	4k	8k	dB(A)
Standard	50/60Hz	68.0	66.5	64.0	59.0	56.0	51.5	48.0	45.5	62.0
Low noise mode	50/60Hz	64.0	62.5	52.0	47.5	44.5	41.5	42.5	40.5	52.5

When Low noise mode is set, the A/C system's capacity is limited. The system could return to normal operation from Low noise mode automatically in the case that the operation condition is severe.

Sound level of PUHY-P500YSJM-A1(-BS)

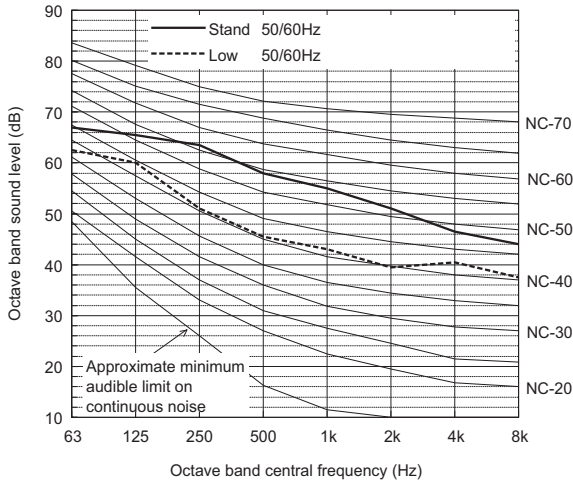

		63	125	250	500	1k	2k	4k	8k	dB(A)
Standard	50/60Hz	67.0	65.5	63.5	58.0	55.0	51.0	46.5	44.0	61.0
Low noise mode	50/60Hz	62.5	60.0	51.0	45.5	43.0	39.5	40.5	37.5	50.5

When Low noise mode is set, the A/C system's capacity is limited. The system could return to normal operation from Low noise mode automatically in the case that the operation condition is severe.

Measurement condition
PUHY-P600,650,700YSJM-A(1)(-BS)

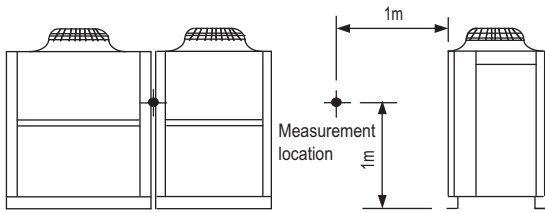

Sound level of PUHY-P700YSJM-A1(-BS)

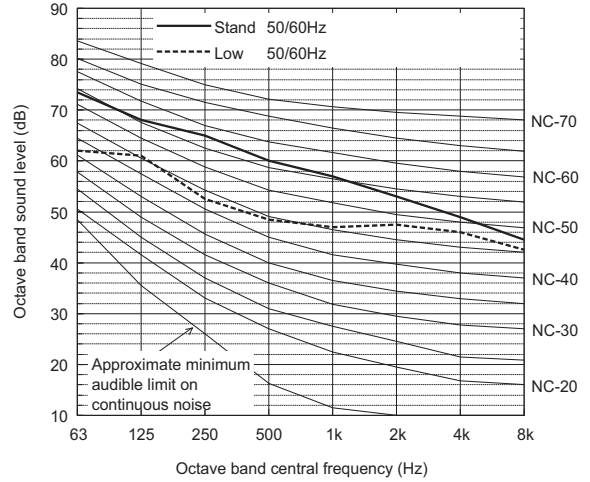

		63	125	250	500	1k	2k	4k	8k	dB(A)
Standard	50/60Hz	73.5	68.0	65.0	60.0	57.0	53.0	49.0	44.5	63.0
Low noise mode	50/60Hz	62.0	61.0	52.5	48.5	47.0	47.5	46.0	42.5	54.5

When Low noise mode is set, the A/C system's capacity is limited. The system could return to normal operation from Low noise mode automatically in the case that the operation condition is severe.

Sound level of PUHY-P600YSJM-A(-BS)

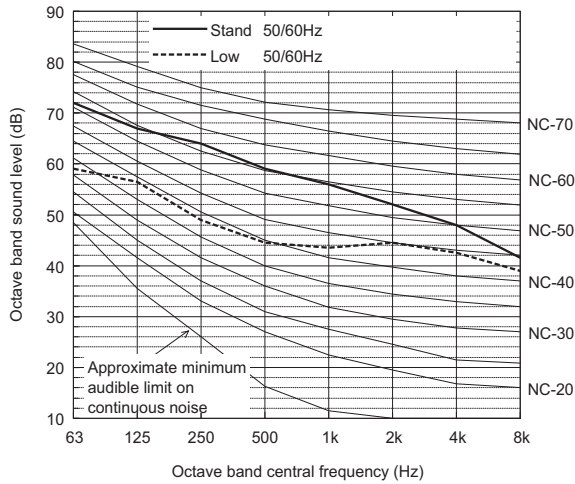

		63	125	250	500	1k	2k	4k	8k	dB(A)
Standard	50/60Hz	72.0	67.0	64.0	59.0	56.0	52.0	48.0	41.5	62.0
Low noise mode	50/60Hz	59.0	56.5	49.0	44.5	43.5	44.5	42.5	39.0	51.0

When Low noise mode is set, the A/C system's capacity is limited. The system could return to normal operation from Low noise mode automatically in the case that the operation condition is severe.

Sound level of PUHY-P650YSJM-A(-BS)

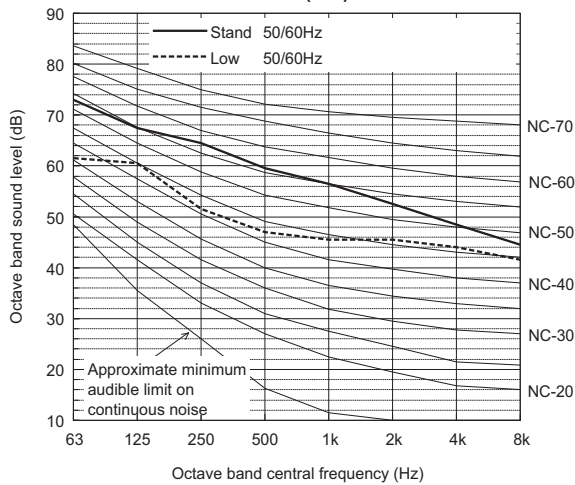

		63	125	250	500	1k	2k	4k	8k	dB(A)
Standard	50/60Hz	73.0	67.5	64.5	59.5	56.5	52.5	48.5	44.5	62.5
Low noise mode	50/60Hz	61.5	60.5	51.5	47.0	45.5	45.5	44.0	41.5	53.0

When Low noise mode is set, the A/C system's capacity is limited. The system could return to normal operation from Low noise mode automatically in the case that the operation condition is severe.

Y

Measurement condition
PUHY-P700,750,800YSJM-A(1)(-BS)

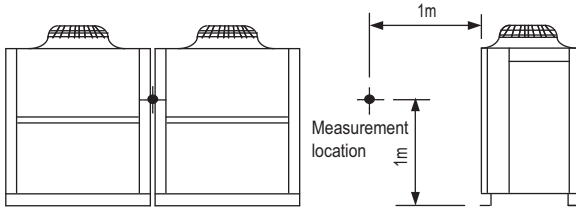

Sound level of PUHY-P800YSJM-A1(-BS)

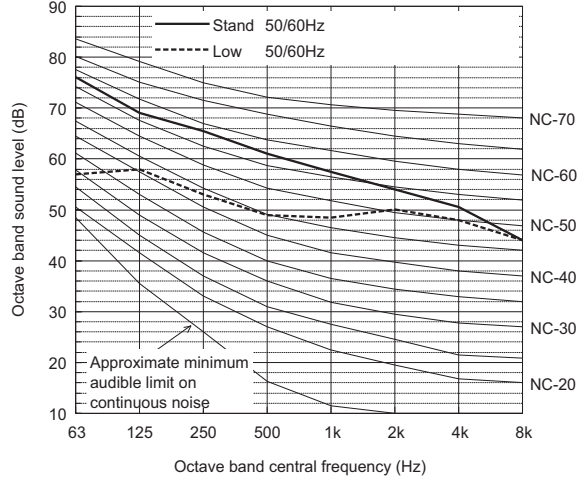

		63	125	250	500	1k	2k	4k	8k	dB(A)
Standard	50/60Hz	76.0	69.0	65.5	61.0	57.5	54.0	50.5	44.0	64.0
Low noise mode	50/60Hz	57.0	58.0	53.0	49.0	48.5	50.0	48.0	44.0	56.0

When Low noise mode is set, the A/C system's capacity is limited. The system could return to normal operation from Low noise mode automatically in the case that the operation condition is severe.

Sound level of PUHY-P700YSJM-A(-BS)

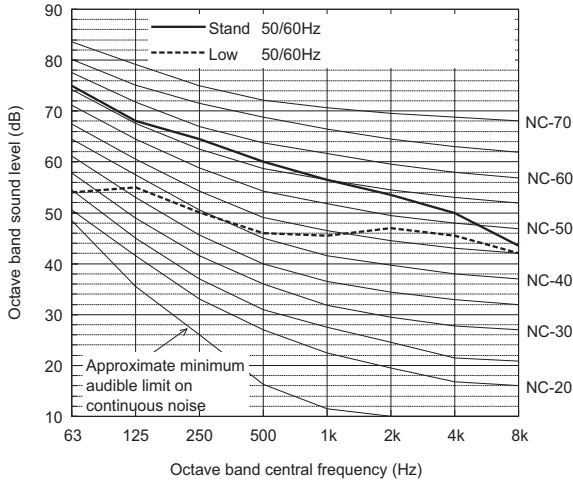

		63	125	250	500	1k	2k	4k	8k	dB(A)
Standard	50/60Hz	75.0	68.0	64.5	60.0	56.5	53.5	50.0	43.5	63.0
Low noise mode	50/60Hz	54.0	55.0	50.0	46.0	45.5	47.0	45.5	42.0	53.0

When Low noise mode is set, the A/C system's capacity is limited. The system could return to normal operation from Low noise mode automatically in the case that the operation condition is severe.

Sound level of PUHY-P750YSJM-A(-BS)

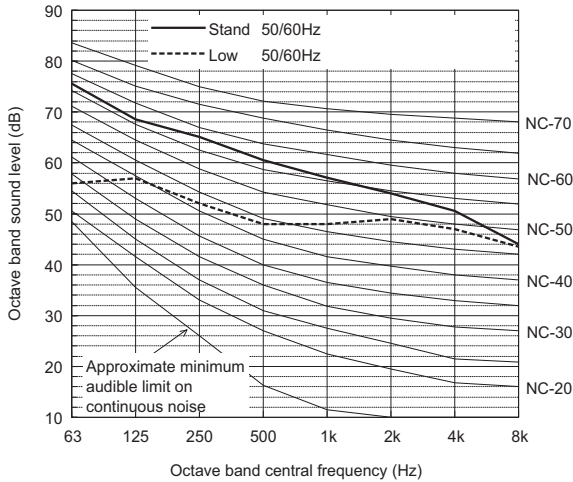

		63	125	250	500	1k	2k	4k	8k	dB(A)
Standard	50/60Hz	75.5	68.5	65.0	60.5	57.0	54.0	50.5	44.0	63.5
Low noise mode	50/60Hz	56.0	57.0	52.0	48.0	48.0	49.0	47.0	43.5	55.0

When Low noise mode is set, the A/C system's capacity is limited. The system could return to normal operation from Low noise mode automatically in the case that the operation condition is severe.

Measurement condition
PUHY-P800,850YSJM-A(-BS)

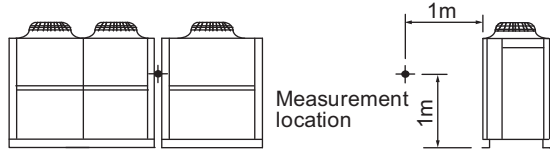

Measurement condition
PUHY-P900YSJM-A(-BS)

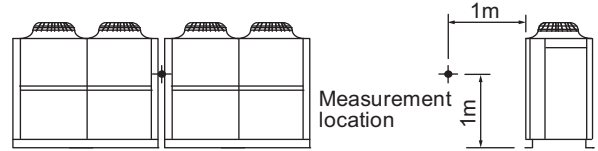

Sound level of PUHY-P800YSJM-A(-BS)

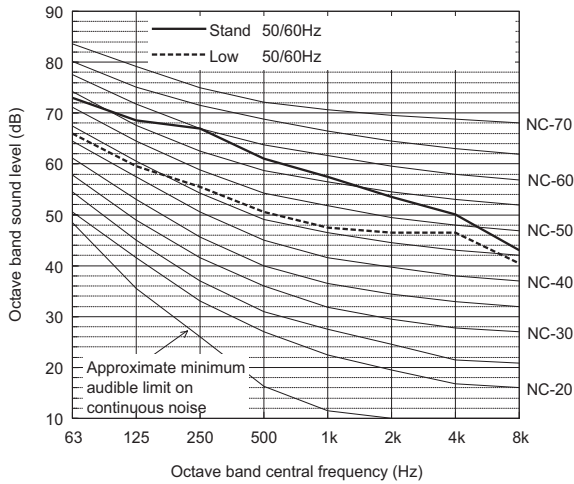

		63	125	250	500	1k	2k	4k	8k	dB(A)
Standard	50/60Hz	73.0	68.5	67.0	61.0	57.5	53.5	50.0	43.0	64.0
Low noise mode	50/60Hz	66.0	59.5	55.5	50.5	47.5	46.5	46.5	40.5	55.0

When Low noise mode is set, the A/C system's capacity is limited. The system could return to normal operation from Low noise mode automatically in the case that the operation condition is severe.

Sound level of PUHY-P900YSJM-A(-BS)

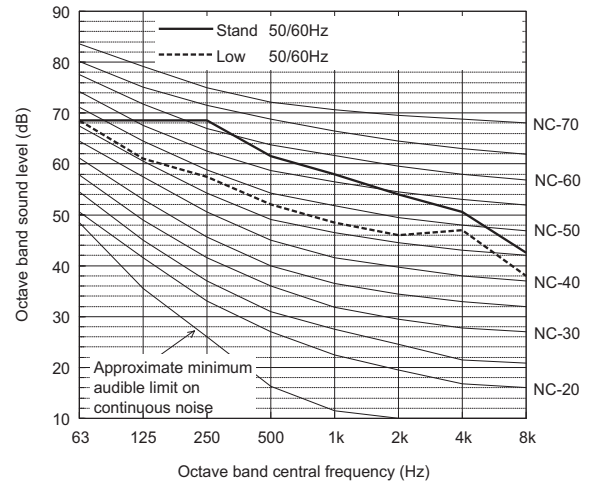

		63	125	250	500	1k	2k	4k	8k	dB(A)
Standard	50/60Hz	68.5	68.5	68.5	61.5	58.0	54.0	50.5	42.5	65.0
Low noise mode	50/60Hz	68.5	61.0	57.5	52.0	48.5	46.0	47.0	38.0	56.0

When Low noise mode is set, the A/C system's capacity is limited. The system could return to normal operation from Low noise mode automatically in the case that the operation condition is severe.

Sound level of PUHY-P850YSJM-A(-BS)

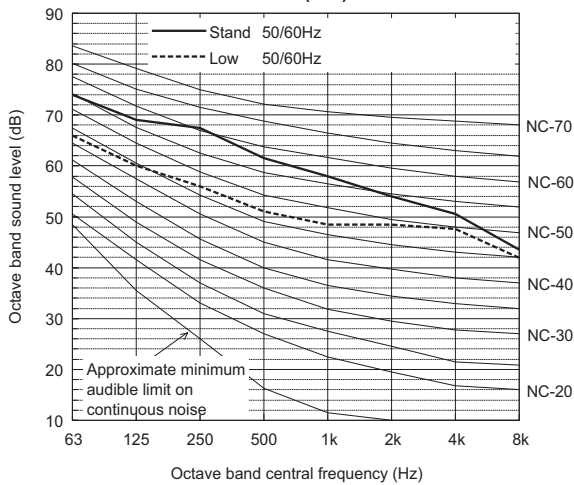

		63	125	250	500	1k	2k	4k	8k	dB(A)
Standard	50/60Hz	74.0	69.0	67.5	61.5	58.0	54.0	50.5	43.5	64.5
Low noise mode	50/60Hz	66.0	60.0	56.0	51.0	48.5	48.5	47.5	42.0	56.0

When Low noise mode is set, the A/C system's capacity is limited. The system could return to normal operation from Low noise mode automatically in the case that the operation condition is severe.

Y

Measurement condition
PUHY-P950,1000YSJM-A(-BS)

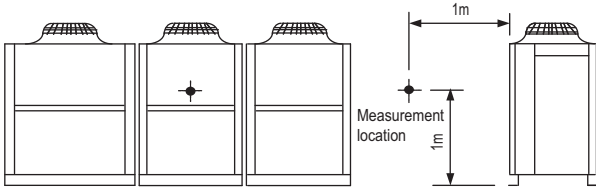

Measurement condition
PUHY-P1050YSJM-A(-BS)

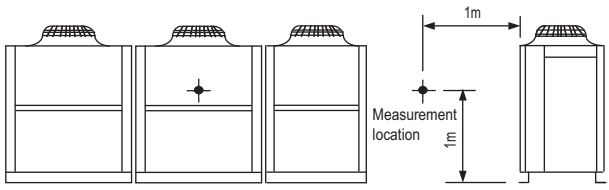

Sound level of PUHY-P950YSJM-A(-BS)

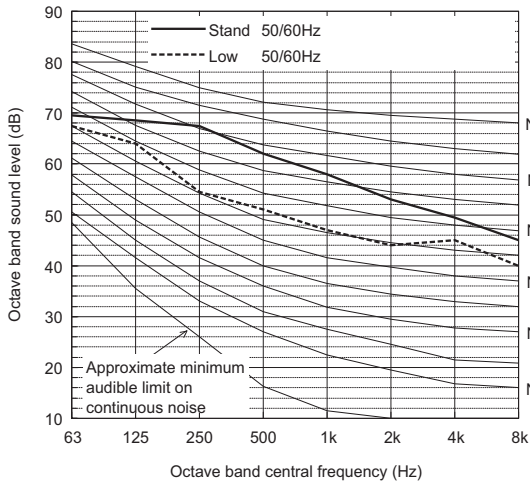

		63	125	250	500	1k	2k	4k	8k	dB(A)
Standard	50/60Hz	69.5	68.5	67.5	62.0	58.0	53.0	49.5	45.0	64.5
Low noise mode	50/60Hz	67.5	64.0	54.5	51.0	47.0	44.0	45.0	40.0	55.0

When Low noise mode is set, the A/C system's capacity is limited. The system could return to normal operation from Low noise mode automatically in the case that the operation condition is severe.

Sound level of PUHY-P1050YSJM-A(-BS)

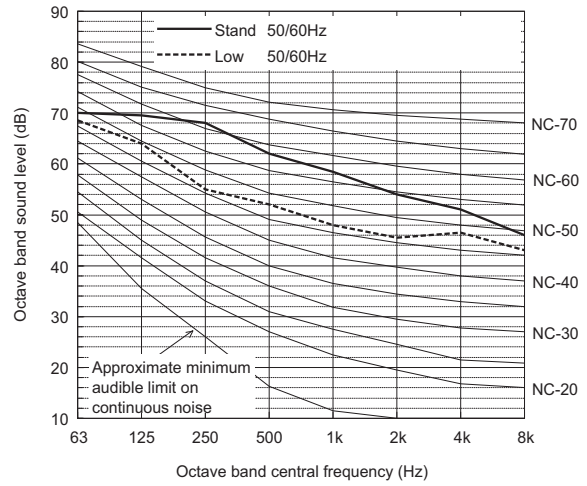

		63	125	250	500	1k	2k	4k	8k	dB(A)
Standard	50/60Hz	70.0	69.5	68.0	62.0	58.5	54.0	51.0	46.0	65.0
Low noise mode	50/60Hz	68.5	64.0	55.0	52.0	48.0	45.5	46.5	43.0	56.0

When Low noise mode is set, the A/C system's capacity is limited. The system could return to normal operation from Low noise mode automatically in the case that the operation condition is severe.

Sound level of PUHY-P1000YSJM-A(-BS)

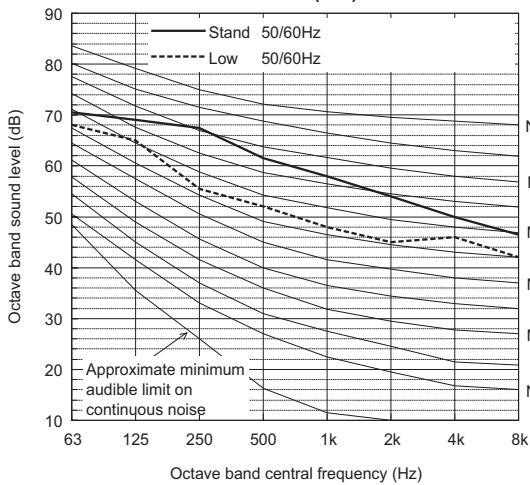

		63	125	250	500	1k	2k	4k	8k	dB(A)
Standard	50/60Hz	70.5	69.0	67.5	61.5	58.0	54.0	50.0	46.5	64.5
Low noise mode	50/60Hz	68.0	65.0	55.5	52.0	48.0	45.0	46.0	42.0	56.0

When Low noise mode is set, the A/C system's capacity is limited. The system could return to normal operation from Low noise mode automatically in the case that the operation condition is severe.

**Measurement condition
PUHY-P1100YSJM-A(-BS)**

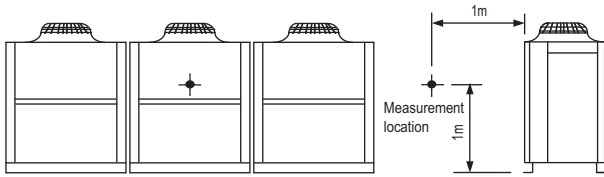

**Measurement condition
PUHY-P1150,1200YSJM-A(-BS)**

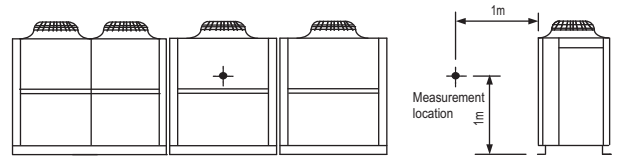

Sound level of PUHY-P1100YSJM-A(-BS)

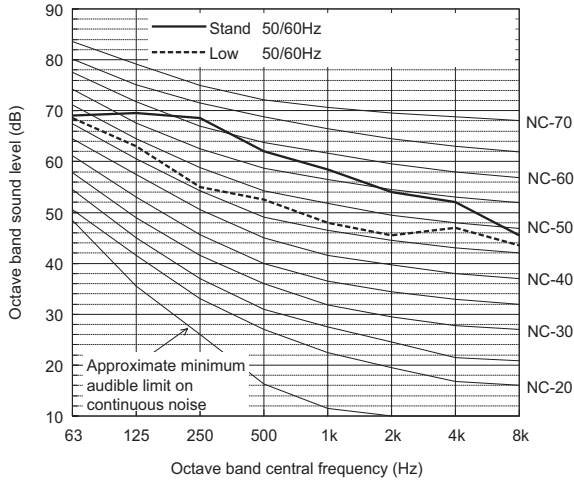

		63	125	250	500	1k	2k	4k	8k	dB(A)
Standard	50/60Hz	69.0	69.5	68.5	62.0	58.5	54.0	52.0	45.5	65.0
Low noise mode	50/60Hz	68.5	63.0	55.0	52.5	48.0	45.5	47.0	43.5	56.0

When Low noise mode is set, the A/C system's capacity is limited. The system could return to normal operation from Low noise mode automatically in the case that the operation condition is severe.

Sound level of PUHY-P1150YSJM-A(-BS)

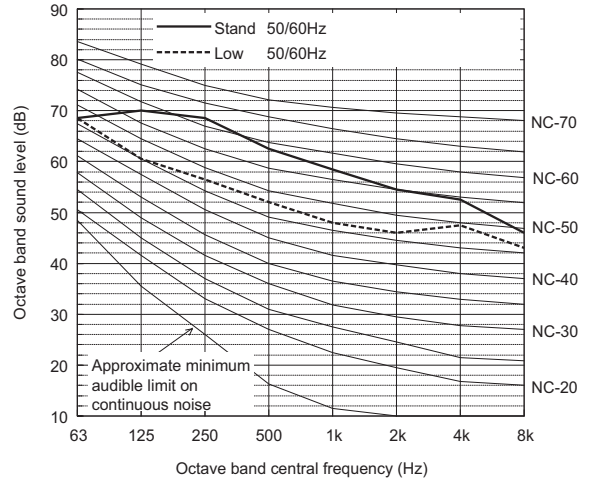

		63	125	250	500	1k	2k	4k	8k	dB(A)
Standard	50/60Hz	68.5	70.0	68.5	62.5	58.5	54.5	52.5	46.0	65.5
Low noise mode	50/60Hz	68.5	60.5	56.5	52.0	48.0	46.0	47.5	43.0	56.0

When Low noise mode is set, the A/C system's capacity is limited. The system could return to normal operation from Low noise mode automatically in the case that the operation condition is severe.

Sound level of PUHY-P1200YSJM-A(-BS)

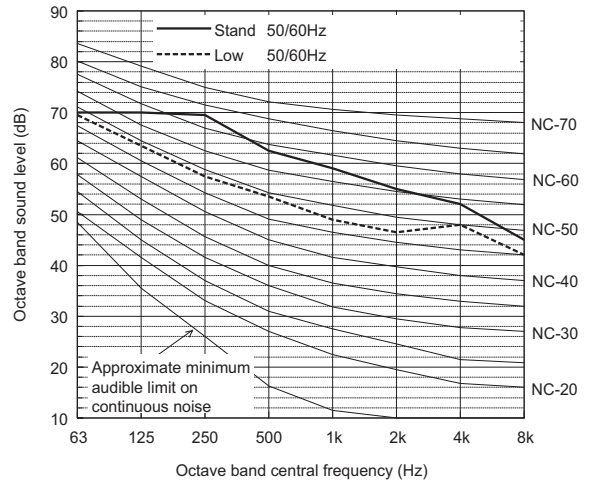

		63	125	250	500	1k	2k	4k	8k	dB(A)
Standard	50/60Hz	70.0	70.0	69.5	62.5	59.0	55.0	52.0	45.0	66.0
Low noise mode	50/60Hz	69.5	63.5	57.5	53.5	49.0	46.5	48.0	42.0	57.0

When Low noise mode is set, the A/C system's capacity is limited. The system could return to normal operation from Low noise mode automatically in the case that the operation condition is severe.

Y

Measurement condition
PUHY-P1250YSJM-A(-BS)



Sound level of PUHY-P1250YSJM-A(-BS)

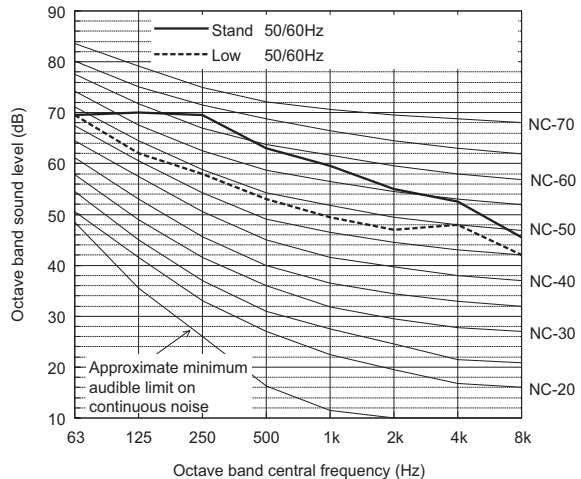

		63	125	250	500	1k	2k	4k	8k	dB(A)
Standard	50/60Hz	69.5	70.0	69.5	63.0	59.5	55.0	52.5	45.5	66.0
Low noise mode	50/60Hz	69.5	62.0	58.0	53.0	49.5	47.0	48.0	42.0	57.0

When Low noise mode is set, the A/C system's capacity is limited. The system could return to normal operation from Low noise mode automatically in the case that the operation condition is severe.

6-1. Correction by temperature

CITY MULTI could have various capacities at different designing temperatures. Using the nominal cooling/heating capacity values and the ratios below, the capacity can be found for various temperatures.

PUHY-		P200YJM-A	P250YJM-A
Nominal Cooling Capacity	kW	22.4	28.0
	BTU/h	76,400	95,500
Input	kW	5.62	7.40

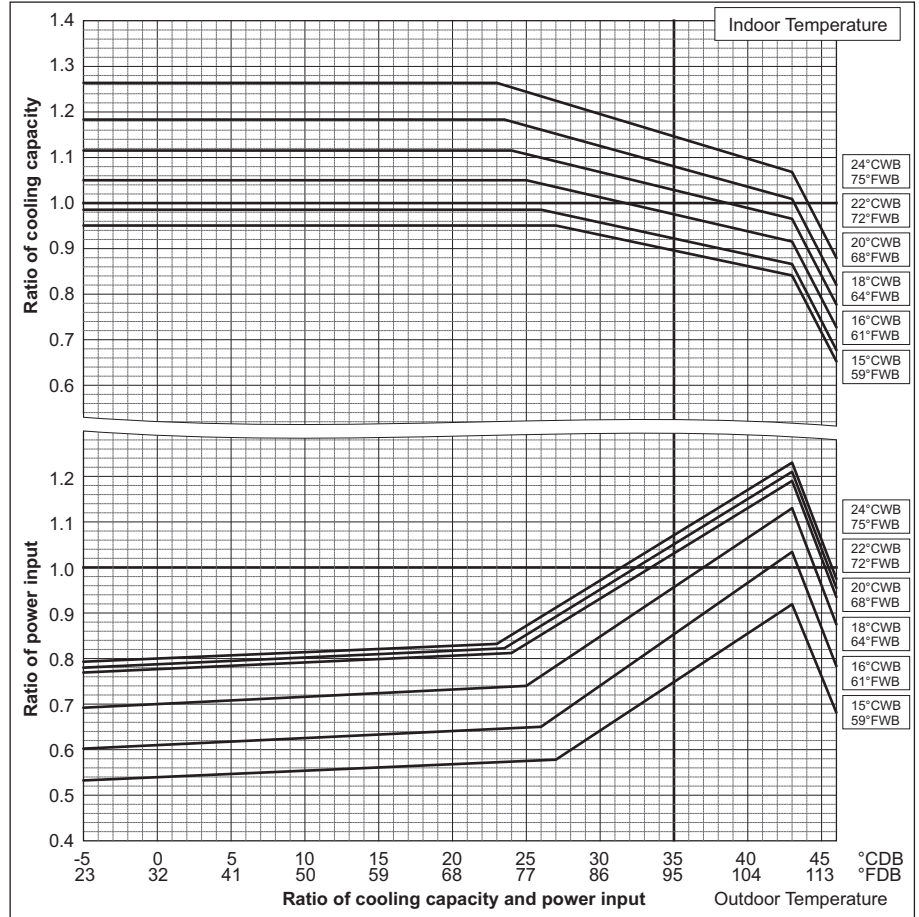

PUHY-		P200YJM-A	P250YJM-A
Nominal Heating Capacity	kW	25.0	31.5
	BTU/h	85,300	107,500
Input	kW	5.84	7.34

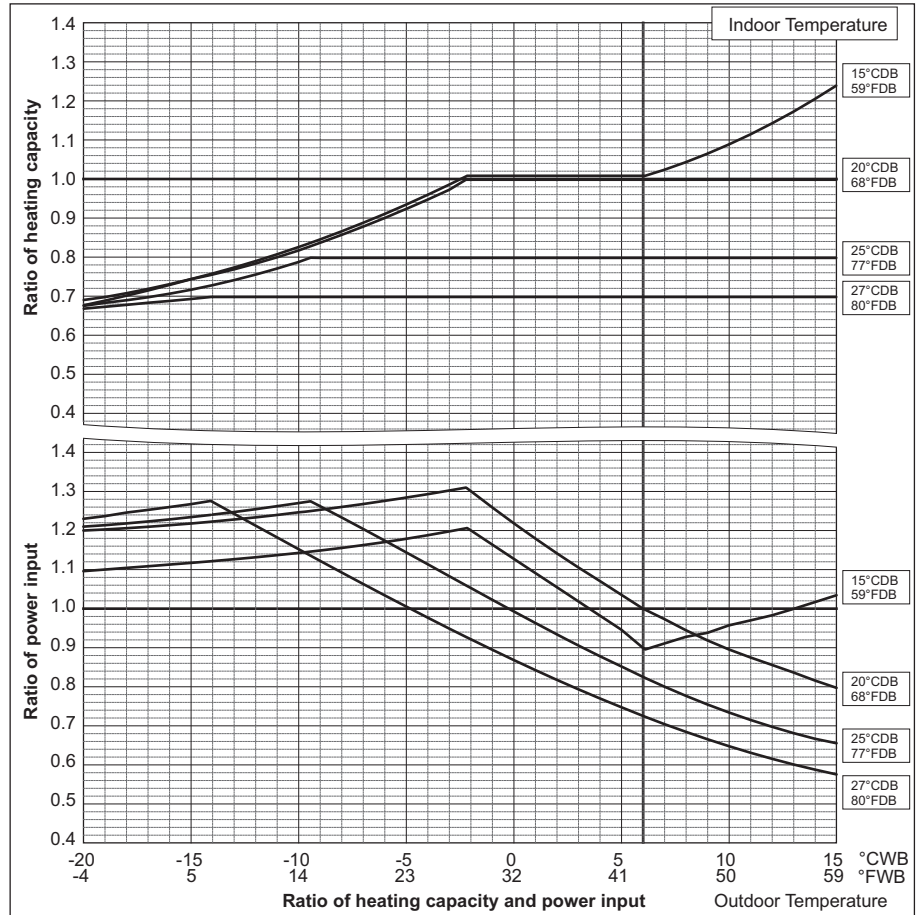

6. CAPACITY TABLES

PUHY-		P300YJM-A	P350YJM-A
Nominal Cooling Capacity	kW	33.5	40.0
	BTU/h	114,300	136,500
Input	kW	9.00	11.01

PUHY-		P400YJM-A
Nominal Cooling Capacity	kW	45.0
	BTU/h	153,500
Input	kW	13.11

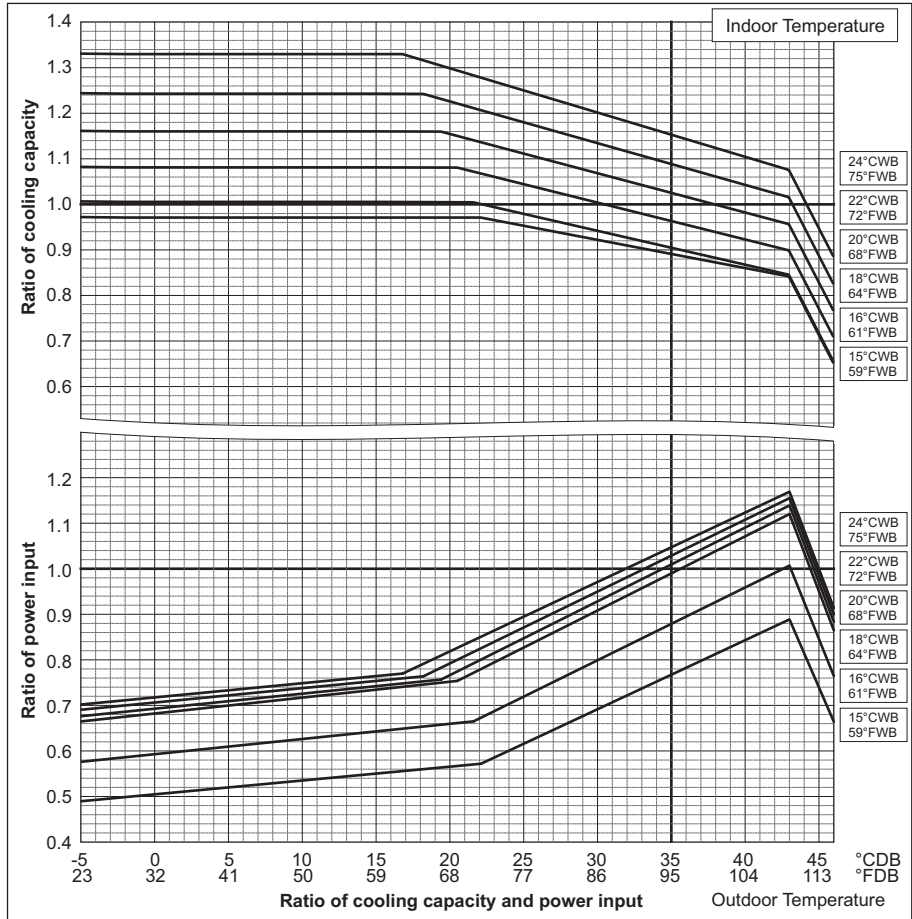

PUHY-		P300YJM-A	P350YJM-A
Nominal Heating Capacity	kW	37.5	45.0
	BTU/h	128,000	153,500
Input	kW	9.25	11.19

PUHY-		P400YJM-A
Nominal Heating Capacity	kW	50.0
	BTU/h	170,600
Input	kW	12.82

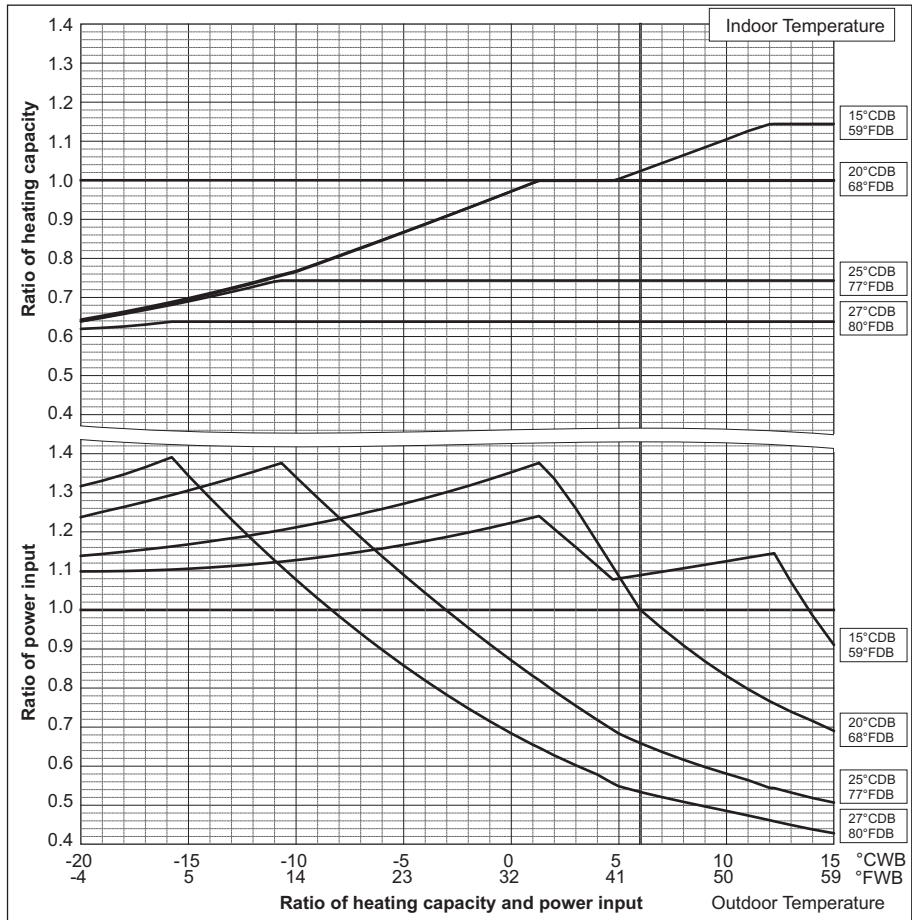

6. CAPACITY TABLES

PUHY-		P450YJM-A	P500YSJM-A
Nominal Cooling Capacity	kW	50.0	56.0
	BTU/h	170,600	191,100
Input	kW	15.47	15.38

PUHY-		P500YSJM-A1	P550YSJM-A
Nominal Cooling Capacity	kW	56.0	63.0
	BTU/h	191,100	215,000
Input	kW	15.05	17.16

PUHY-		P600YSJM-A	P600YSJM-A1
Nominal Cooling Capacity	kW	69.0	69.0
	BTU/h	235,400	235,400
Input	kW	18.75	19.00

PUHY-		P650YSJM-A
Nominal Cooling Capacity	kW	73.0
	BTU/h	249,100
Input	kW	20.39

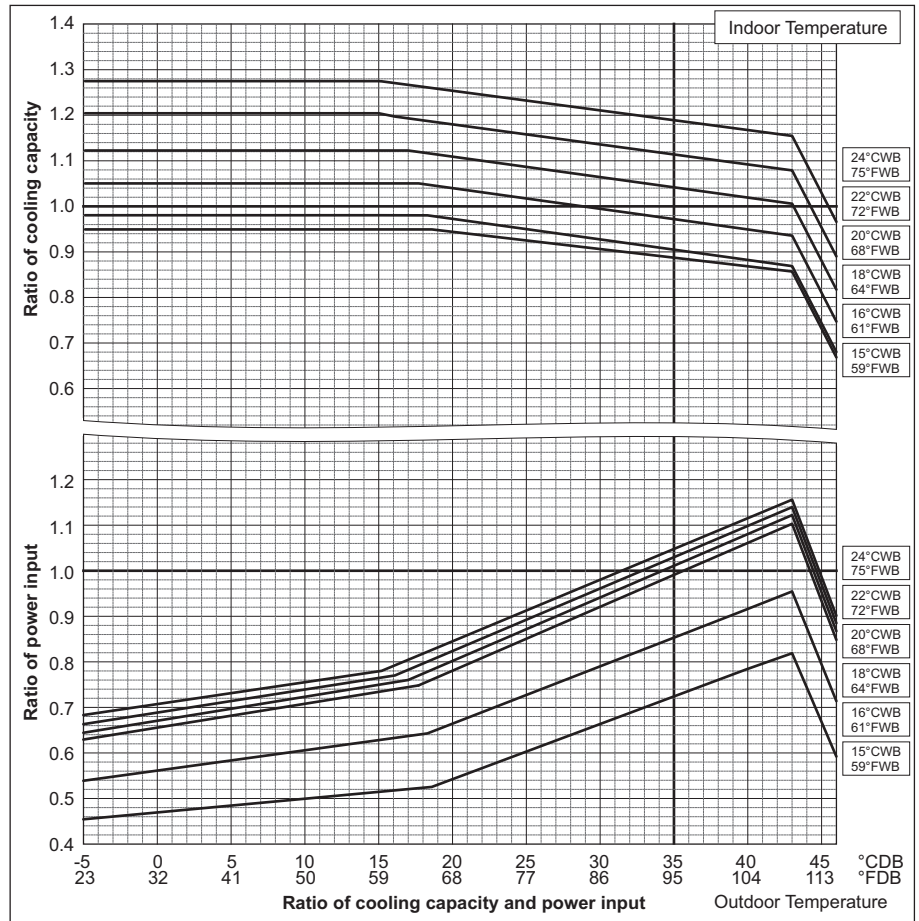

PUHY-		P450YJM-A	P500YSJM-A
Nominal Heating Capacity	kW	56.0	63.0
	BTU/h	191,000	215,000
Input	kW	14.62	15.03

PUHY-		P500YSJM-A1	P550YSJM-A
Nominal Heating Capacity	kW	63.0	69.0
	BTU/h	215,000	235,400
Input	kW	15.51	16.87

PUHY-		P600YSJM-A	P600YSJM-A1
Nominal Heating Capacity	kW	76.5	76.5
	BTU/h	261,000	261,000
Input	kW	18.88	19.26

PUHY-		P650YSJM-A
Nominal Heating Capacity	kW	81.5
	BTU/h	278,100
Input	kW	20.47

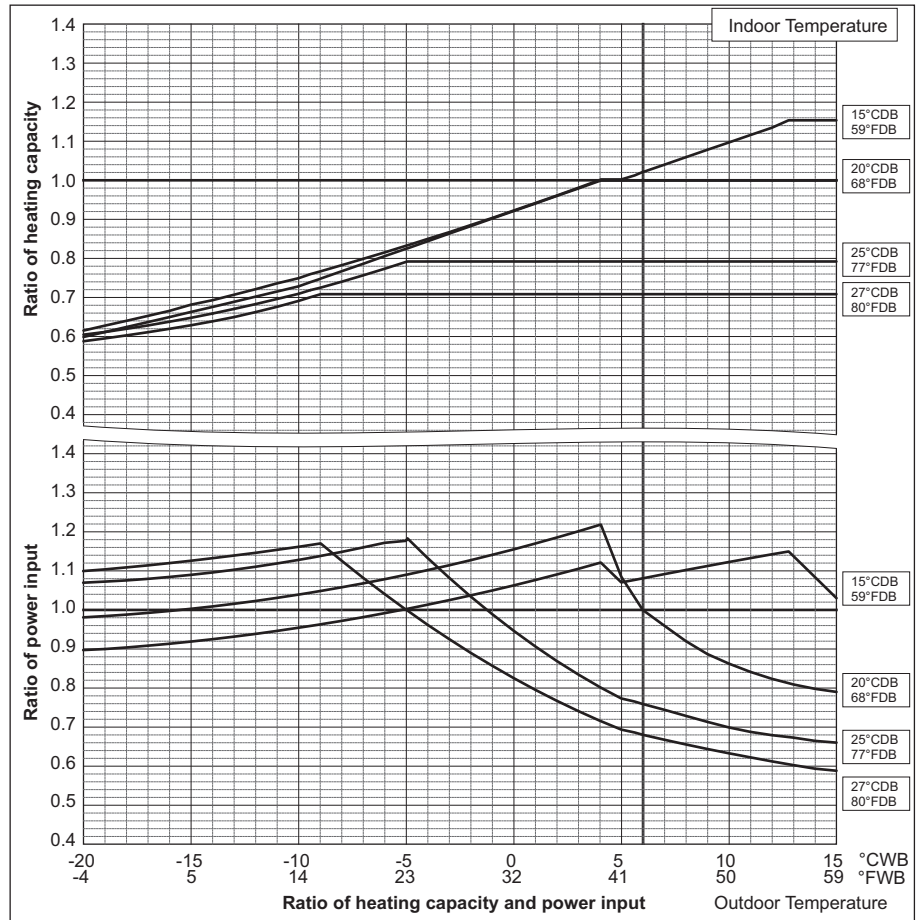

6. CAPACITY TABLES

PUHY-		P700YSJM-A	P700YSJM-A1
Nominal Cooling Capacity	kW	80.0	80.0
	BTU/h	273,000	273,000
Input	kW	22.47	23.05

PUHY-		P750YSJM-A	P800YSJM-A
Nominal Cooling Capacity	kW	85.0	90.0
	BTU/h	290,000	307,100
Input	kW	24.70	27.10

PUHY-		P800YSJM-A1
Nominal Cooling Capacity	kW	90.0
	BTU/h	307,100
Input	kW	26.86

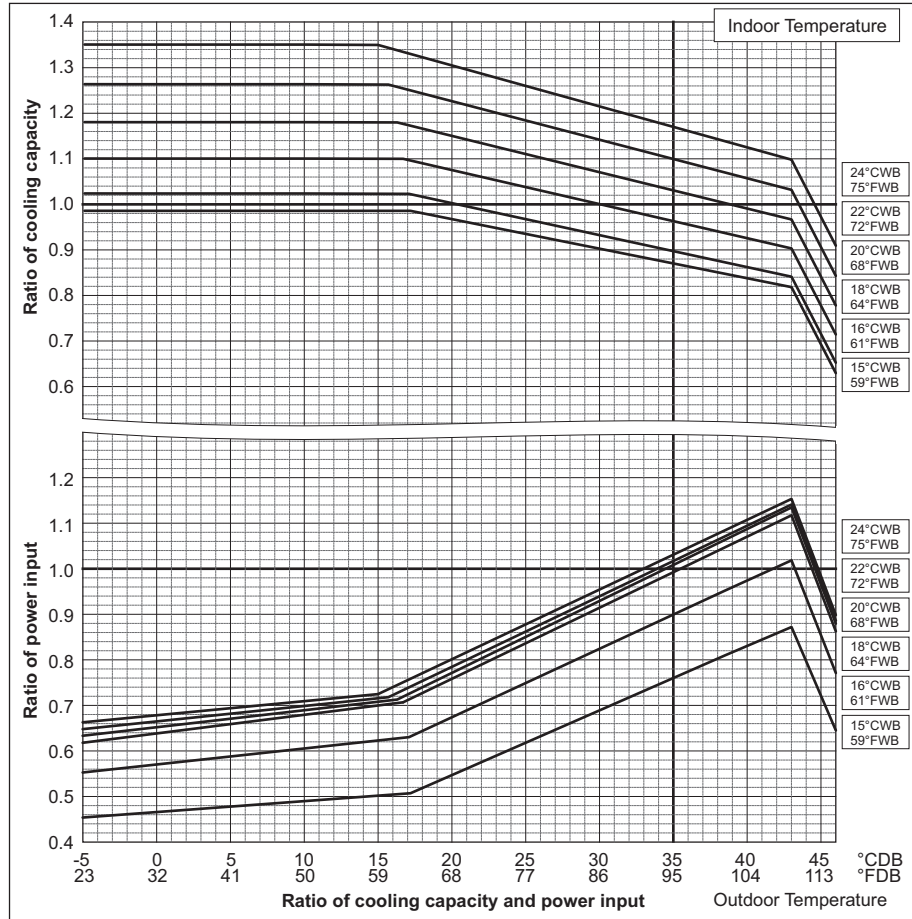

PUHY-		P700YSJM-A	P700YSJM-A1
Nominal Heating Capacity	kW	88.0	88.0
	BTU/h	300,300	300,300
Input	kW	22.27	23.09

PUHY-		P750YSJM-A	P800YSJM-A
Nominal Heating Capacity	kW	95.0	100.0
	BTU/h	324,100	341,200
Input	kW	24.67	25.70

PUHY-		P800YSJM-A1
Nominal Heating Capacity	kW	100.0
	BTU/h	341,200
Input	kW	27.02

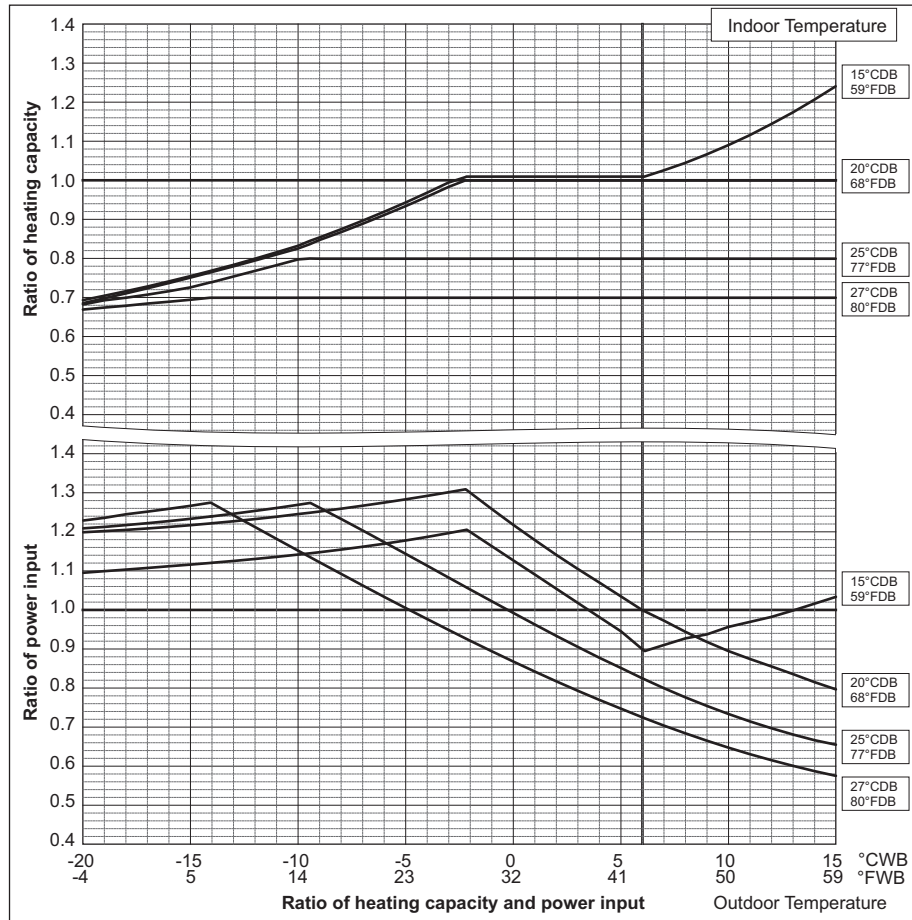

6. CAPACITY TABLES

PUHY-		P850YSJM-A	P900YSJM-A
Nominal Cooling Capacity	kW	96.0	101.0
	BTU/h	327,600	344,600
Input	kW	29.62	32.06

PUHY-		P950YSJM-A	P1000YSJM-A
Nominal Cooling Capacity	kW	108.0	113.0
	BTU/h	368,500	385,600
Input	kW	30.50	32.10

PUHY-		P1050YSJM-A	P1100YSJM-A
Nominal Cooling Capacity	kW	118.0	124.0
	BTU/h	402,600	423,100
Input	kW	33.81	35.73

PUHY-		P1150YSJM-A	P1200YSJM-A
Nominal Cooling Capacity	kW	130.0	136.0
	BTU/h	443,600	464,000
Input	kW	38.34	40.84

PUHY-		P1250YSJM-A
Nominal Cooling Capacity	kW	140.0
	BTU/h	477,700
Input	kW	42.94

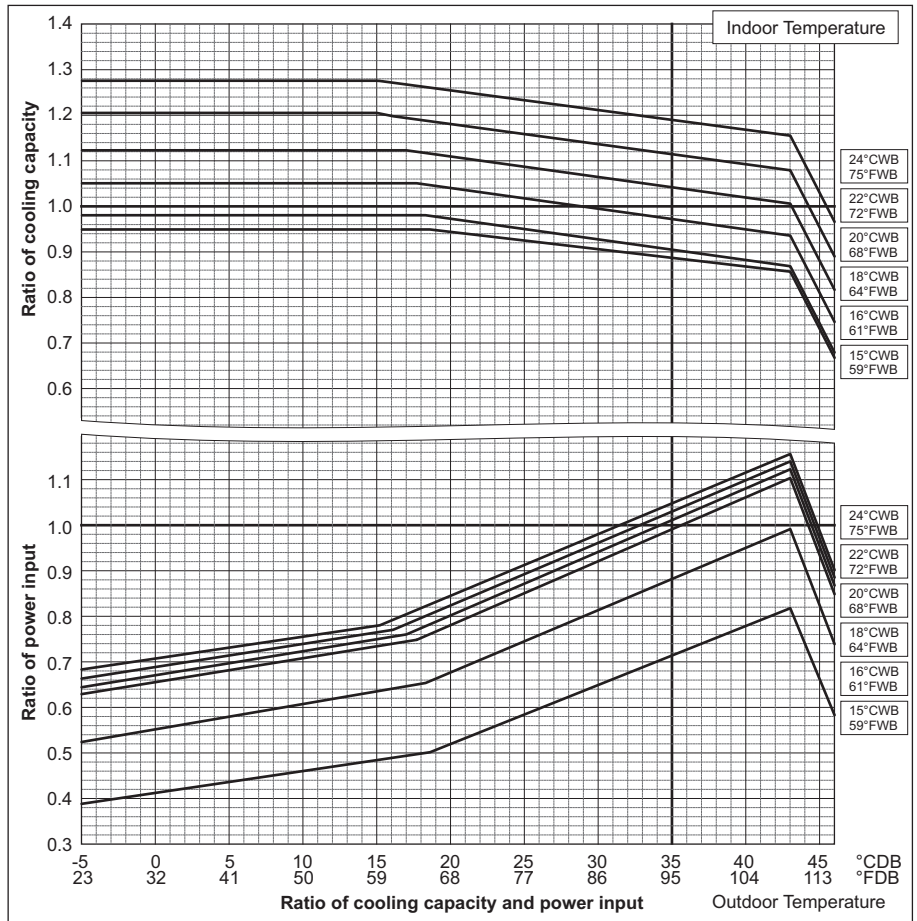

PUHY-		P850YSJM-A	P900YSJM-A
Nominal Heating Capacity	kW	108.0	113.0
	BTU/h	368,500	385,600
Input	kW	28.42	30.05

PUHY-		P950YSJM-A	P1000YSJM-A
Nominal Heating Capacity	kW	119.5	127.0
	BTU/h	407,700	433,300
Input	kW	30.02	33.15

PUHY-		P1050YSJM-A	P1100YSJM-A
Nominal Heating Capacity	kW	132.0	140.0
	BTU/h	450,400	477,700
Input	kW	34.10	36.08

PUHY-		P1150YSJM-A	P1200YSJM-A
Nominal Heating Capacity	kW	145.0	150.0
	BTU/h	494,700	511,800
Input	kW	37.27	39.26

PUHY-		P1250YSJM-A
Nominal Heating Capacity	kW	156.5
	BTU/h	534,000
Input	kW	40.86

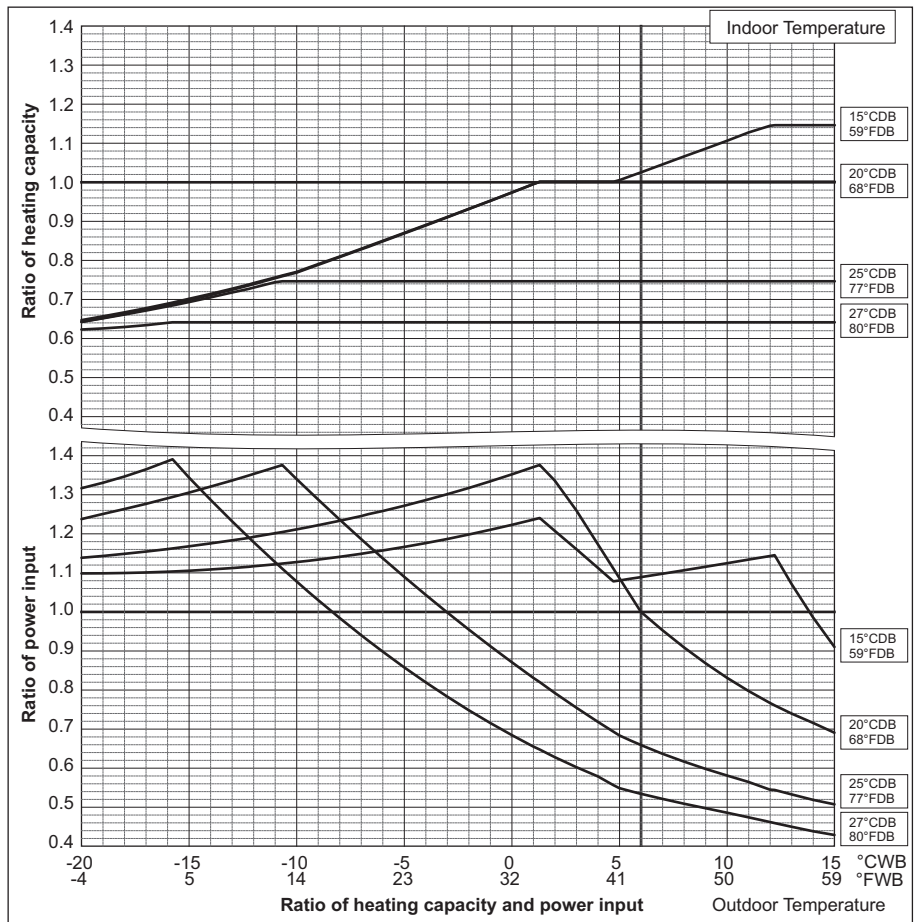

Correction by temperature (COP Priority Mode)

CITY MULTI could have various capacities at different designing temperatures. Using the nominal cooling/heating capacity values and the ratios below, the capacity can be found for various temperatures.

To select COP priority mode, DipSW 3-7 must be set to ON.

PUHY-	P200YJM-A	P250YJM-A
Nominal Cooling Capacity	kW 22.4	28.0
	BTU/h 76,400	95,500
Input	kW 5.62	7.40

(There is no difference in cooling performance between Standard Mode and COP Priority Mode.)

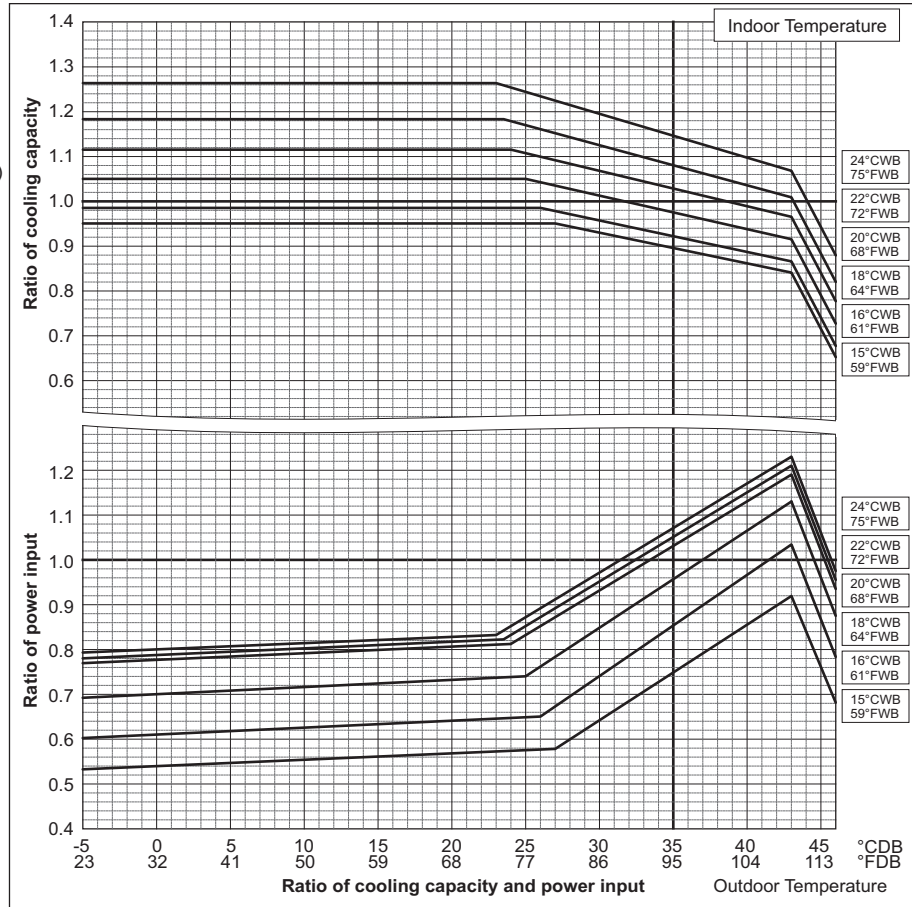

PUHY-	P200YJM-A	P250YJM-A
Nominal Heating Capacity	kW 25.0	31.5
	BTU/h 85,300	107,500
Input	kW 5.84	7.34

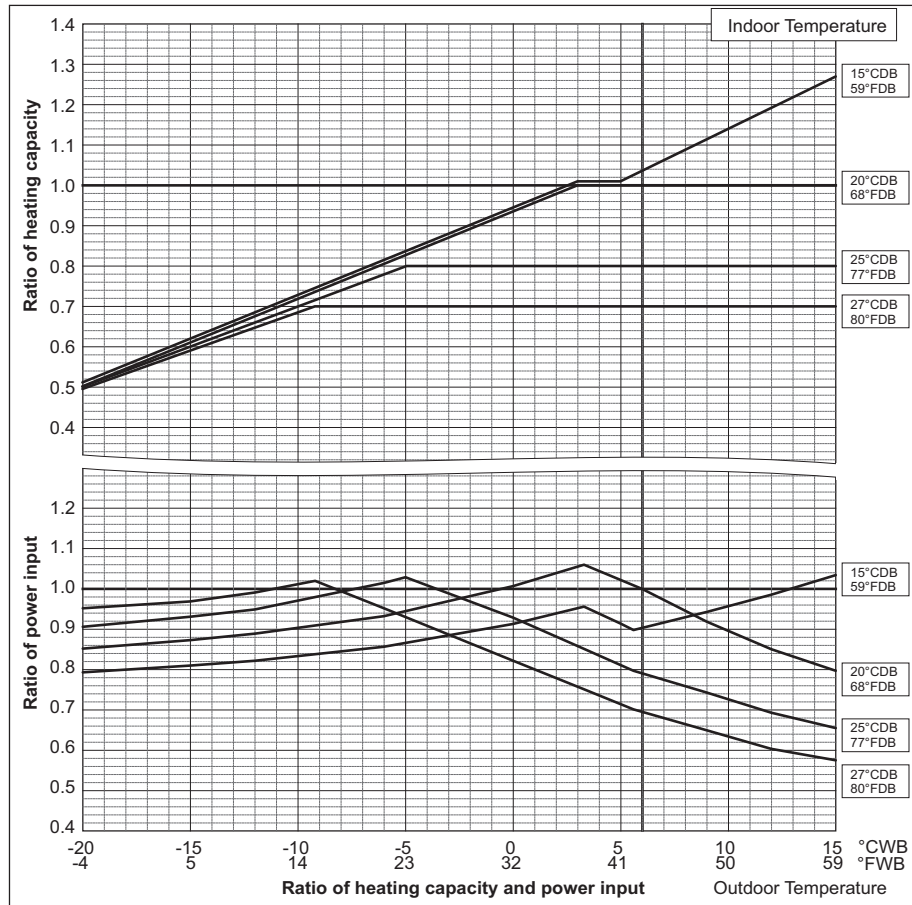

6. CAPACITY TABLES

PUHY-		P300YJM-A	P350YJM-A
Nominal Cooling Capacity	kW	33.5	40.0
	BTU/h	114,300	136,500
Input	kW	9.00	11.01

PUHY-		P400YJM-A
Nominal Cooling Capacity	kW	45.0
	BTU/h	153,500
Input	kW	13.11

(There is no difference in cooling performance between Standard Mode and COP Priority Mode.)

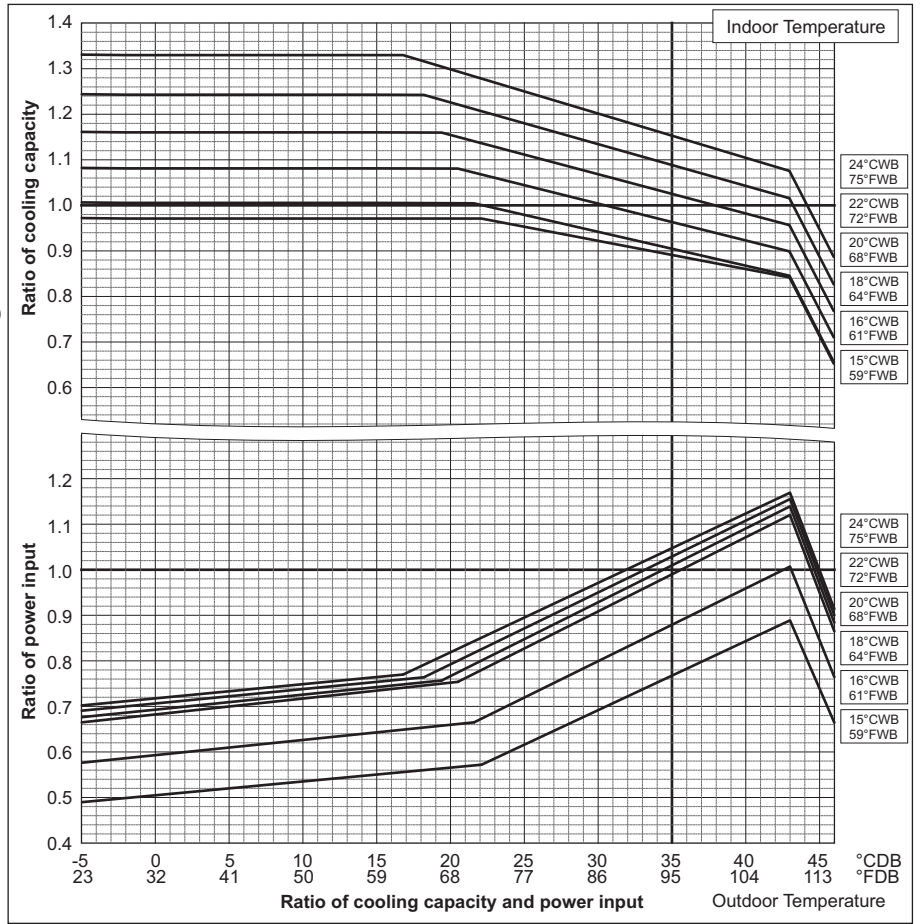

PUHY-		P300YJM-A	P350YJM-A
Nominal Heating Capacity	kW	37.5	45.0
	BTU/h	128,000	153,500
Input	kW	9.25	11.19

PUHY-		P400YJM-A
Nominal Heating Capacity	kW	50.0
	BTU/h	170,600
Input	kW	12.82

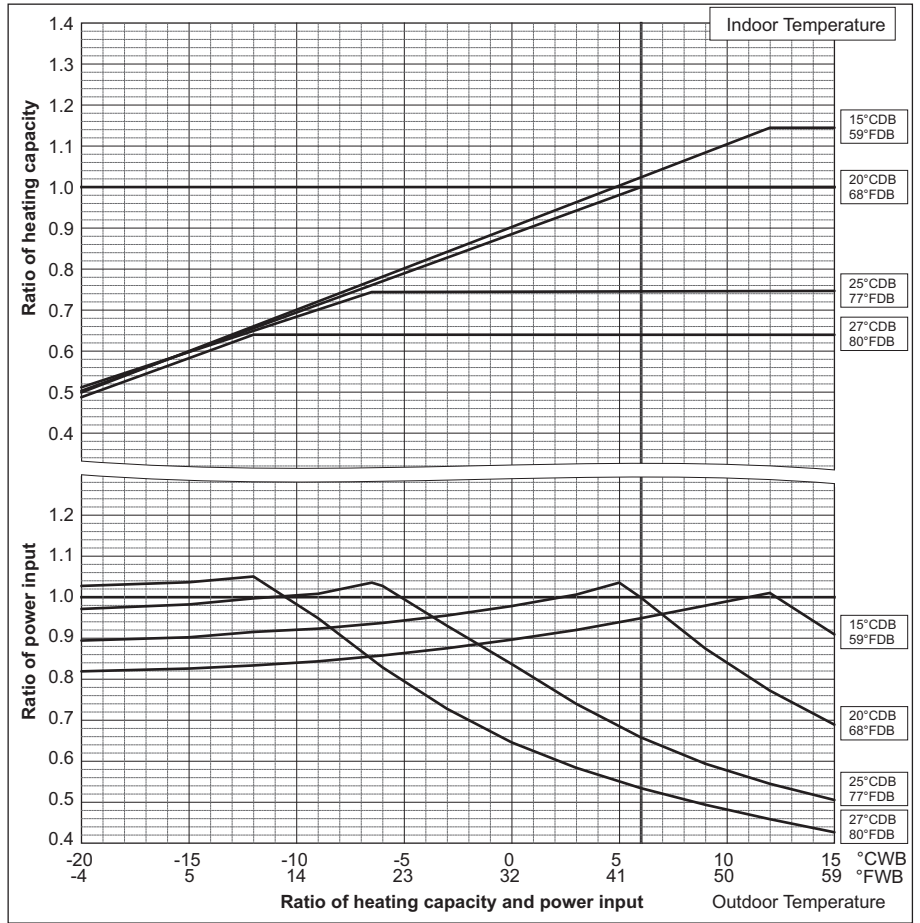

6. CAPACITY TABLES

PUHY-		P450YJM-A	P500YSJM-A
Nominal Cooling Capacity	kW	50.0	56.0
	BTU/h	170,600	191,100
Input	kW	15.47	15.38

PUHY-		P500YSJM-A1	P550YSJM-A
Nominal Cooling Capacity	kW	56.0	63.0
	BTU/h	191,100	215,000
Input	kW	15.05	17.16

PUHY-		P600YSJM-A	P600YSJM-A1
Nominal Cooling Capacity	kW	69.0	69.0
	BTU/h	235,400	235,400
Input	kW	18.75	19.00

PUHY-		P650YSJM-A
Nominal Cooling Capacity	kW	73.0
	BTU/h	249,100
Input	kW	20.39

(There is no difference in cooling performance between Standard Mode and COP Priority Mode.)

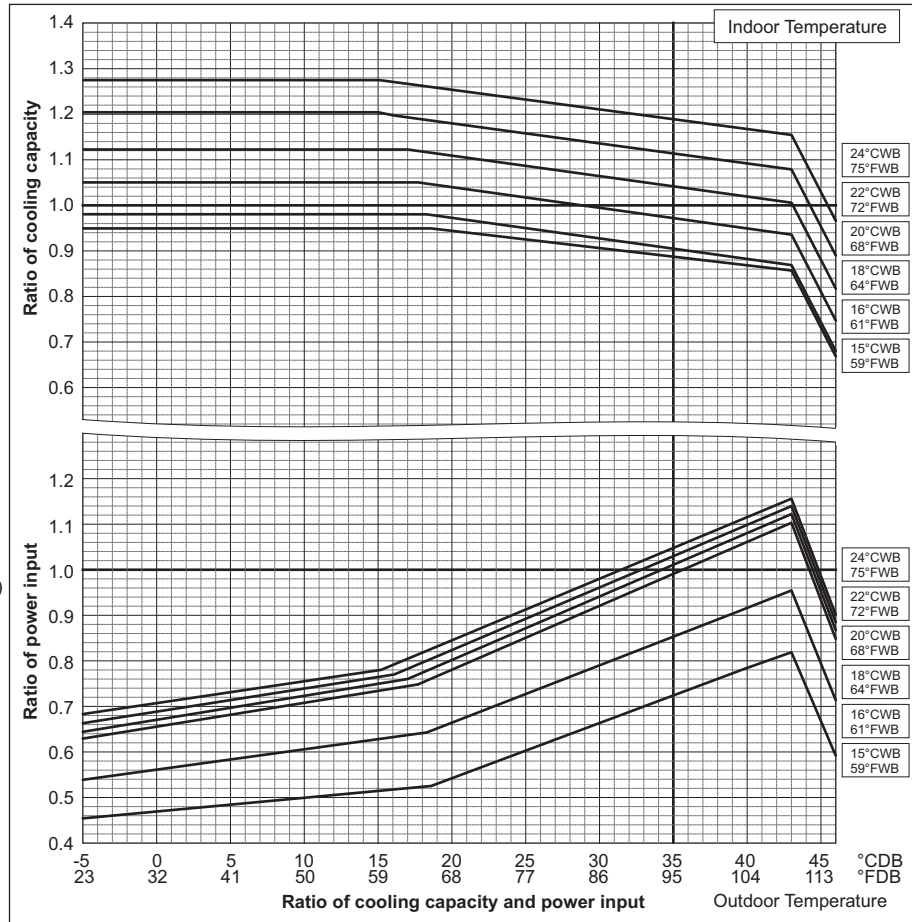

PUHY-		P450YJM-A	P500YSJM-A
Nominal Heating Capacity	kW	56.0	63.0
	BTU/h	191,000	215,000
Input	kW	14.62	15.03

PUHY-		P500YSJM-A1	P550YSJM-A
Nominal Heating Capacity	kW	63.0	69.0
	BTU/h	215,000	235,400
Input	kW	15.51	16.87

PUHY-		P600YSJM-A	P600YSJM-A1
Nominal Heating Capacity	kW	76.5	76.5
	BTU/h	261,000	261,000
Input	kW	18.88	19.26

PUHY-		P650YSJM-A
Nominal Heating Capacity	kW	81.5
	BTU/h	278,100
Input	kW	20.47

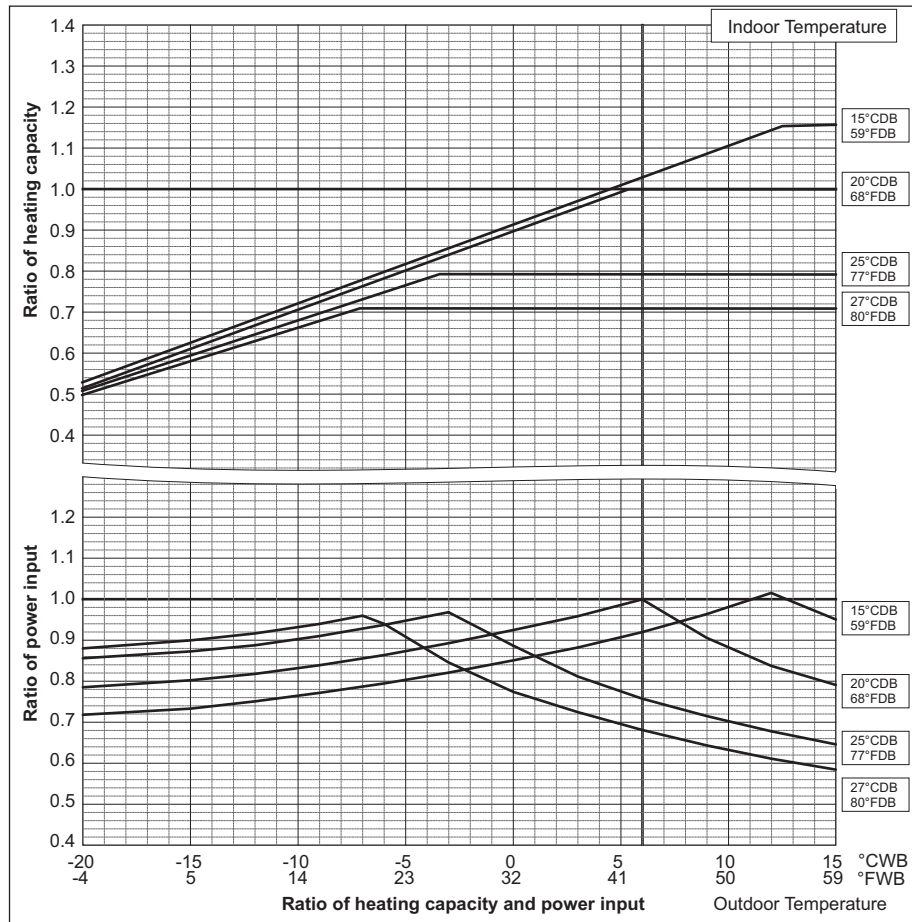

6. CAPACITY TABLES

PUHY-		P700YSJM-A	P700YSJM-A1
Nominal Cooling Capacity	kW	80.0	80.0
	BTU/h	273,000	273,000
Input	kW	22.47	23.05

PUHY-		P750YSJM-A	P800YSJM-A
Nominal Cooling Capacity	kW	85.0	90.0
	BTU/h	290,000	307,100
Input	kW	24.70	27.10

PUHY-		P800YSJM-A1
Nominal Cooling Capacity	kW	90.0
	BTU/h	307,100
Input	kW	26.86

(There is no difference in cooling performance between Standard Mode and COP Priority Mode.)

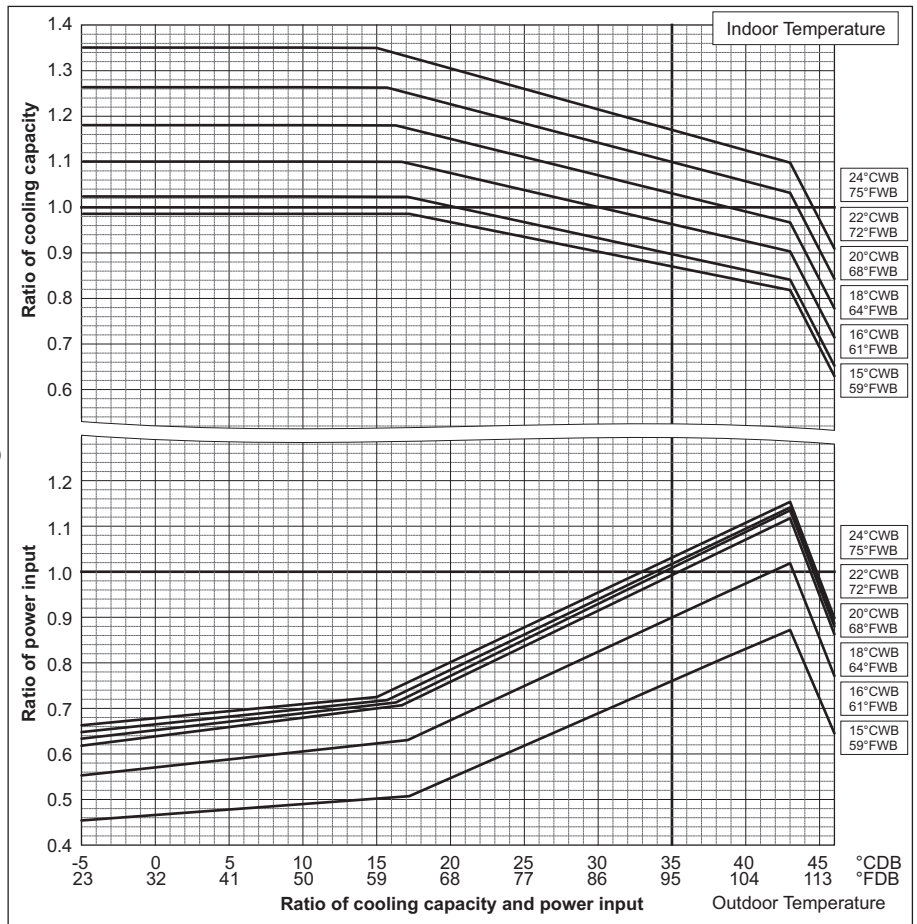

PUHY-		P700YSJM-A	P700YSJM-A1
Nominal Heating Capacity	kW	88.0	88.0
	BTU/h	300,300	300,300
Input	kW	22.27	23.09

PUHY-		P750YSJM-A	P800YSJM-A
Nominal Heating Capacity	kW	95.0	100.0
	BTU/h	324,100	341,200
Input	kW	24.67	25.70

PUHY-		P800YSJM-A1
Nominal Heating Capacity	kW	100.0
	BTU/h	341,200
Input	kW	27.02

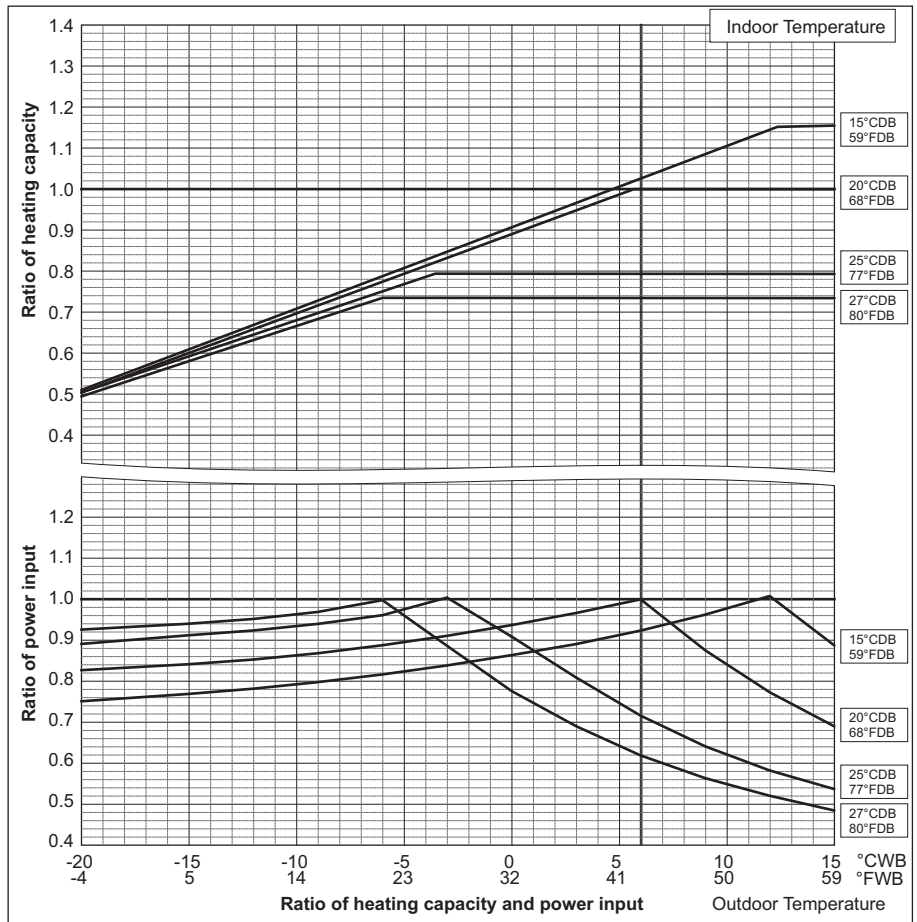

6. CAPACITY TABLES

Y

PUHY-		P850YSJM-A	P900YSJM-A
Nominal Cooling Capacity	kW	96.0	101.0
	BTU/h	327,600	344,600
Input	kW	29.62	32.06

PUHY-		P950YSJM-A	P1000YSJM-A
Nominal Cooling Capacity	kW	108.0	113.0
	BTU/h	368,500	385,600
Input	kW	30.50	32.10

PUHY-		P1050YSJM-A	P1100YSJM-A
Nominal Cooling Capacity	kW	118.0	124.0
	BTU/h	402,600	423,100
Input	kW	33.81	35.73

PUHY-		P1150YSJM-A	P1200YSJM-A
Nominal Cooling Capacity	kW	130.0	136.0
	BTU/h	443,600	464,000
Input	kW	38.34	40.84

PUHY-		P1250YSJM-A
Nominal Cooling Capacity	kW	140.0
	BTU/h	477,700
Input	kW	42.94

(There is no difference in cooling performance between Standard Mode and COP Priority Mode.)

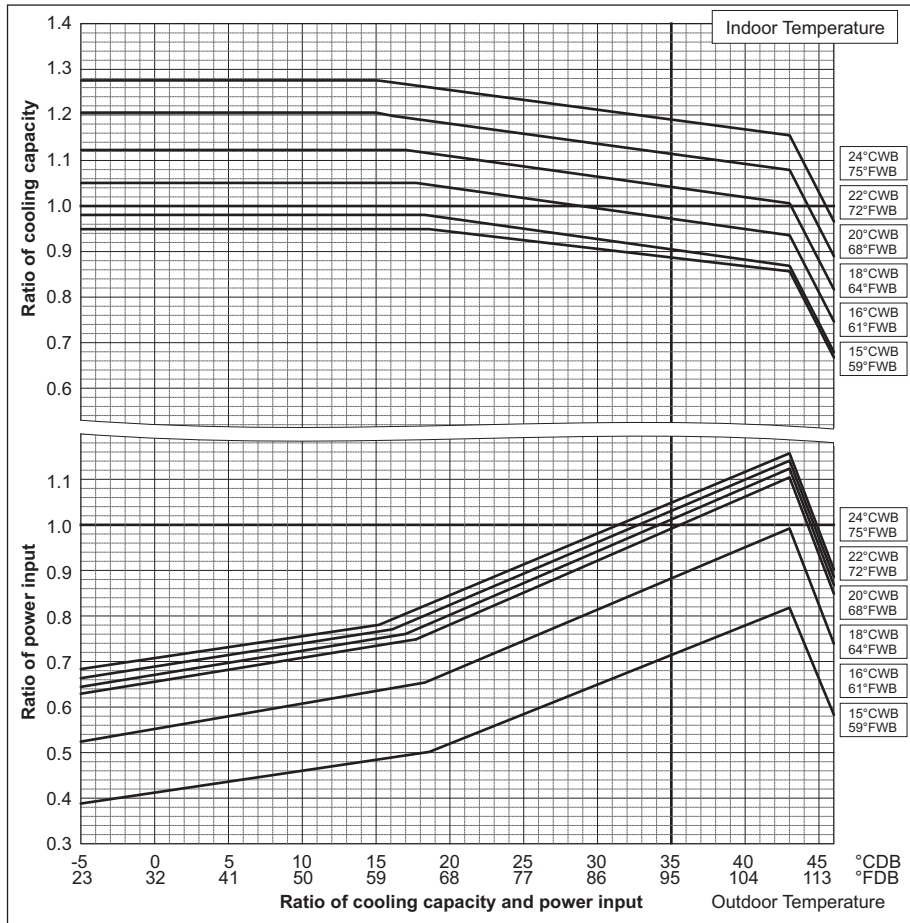

PUHY-		P850YSJM-A	P900YSJM-A
Nominal Heating Capacity	kW	108.0	113.0
	BTU/h	368,500	385,600
Input	kW	28.42	30.05

PUHY-		P950YSJM-A	P1000YSJM-A
Nominal Heating Capacity	kW	119.5	127.0
	BTU/h	407,700	433,300
Input	kW	30.02	33.15

PUHY-		P1050YSJM-A	P1100YSJM-A
Nominal Heating Capacity	kW	132.0	140.0
	BTU/h	450,400	477,700
Input	kW	34.10	36.08

PUHY-		P1150YSJM-A	P1200YSJM-A
Nominal Heating Capacity	kW	145.0	150.0
	BTU/h	494,700	511,800
Input	kW	37.27	39.26

PUHY-		P1250YSJM-A
Nominal Heating Capacity	kW	156.5
	BTU/h	534,000
Input	kW	40.86

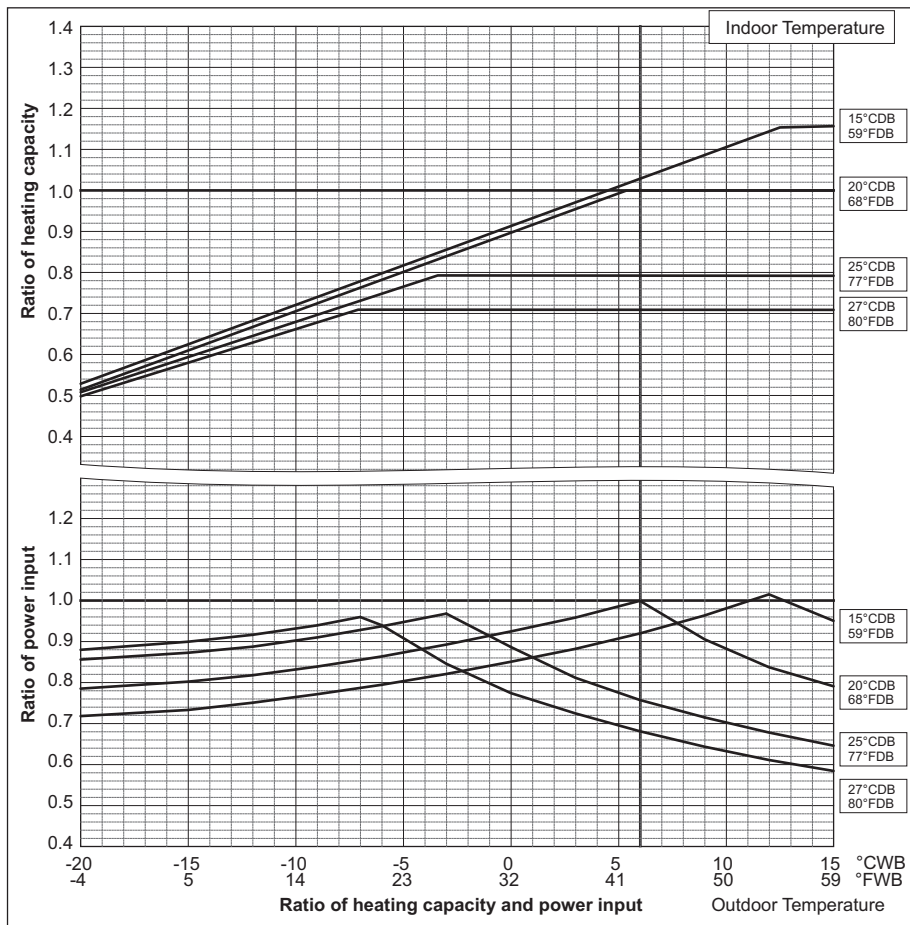

6-2. Correction by total indoor

CITY MULTI system have different capacities and inputs when many combinations of indoor units with different total capacities are connected. Using following tables, the maximum capacity can be found to ensure the system is installed with enough capacity for a particular application.

PUHY-P200YJM-A		
Nominal Cooling Capacity	kW	22.4
	BTU/h	76,400
Input	kW	5.62

PUHY-P200YJM-A		
Nominal Heating Capacity	kW	25.0
	BTU/h	85,300
Input	kW	5.84

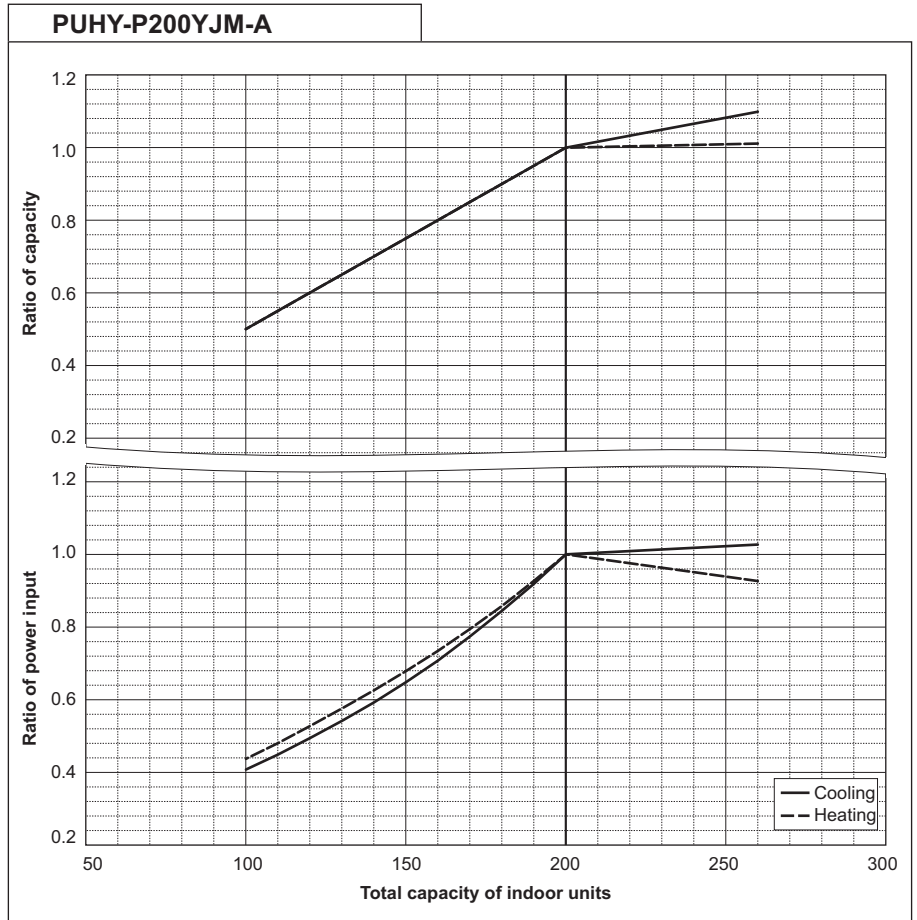

PUHY-P250YJM-A		
Nominal Cooling Capacity	kW	28.0
	BTU/h	95,500
Input	kW	7.40

PUHY-P250YJM-A		
Nominal Heating Capacity	kW	31.5
	BTU/h	107,500
Input	kW	7.34

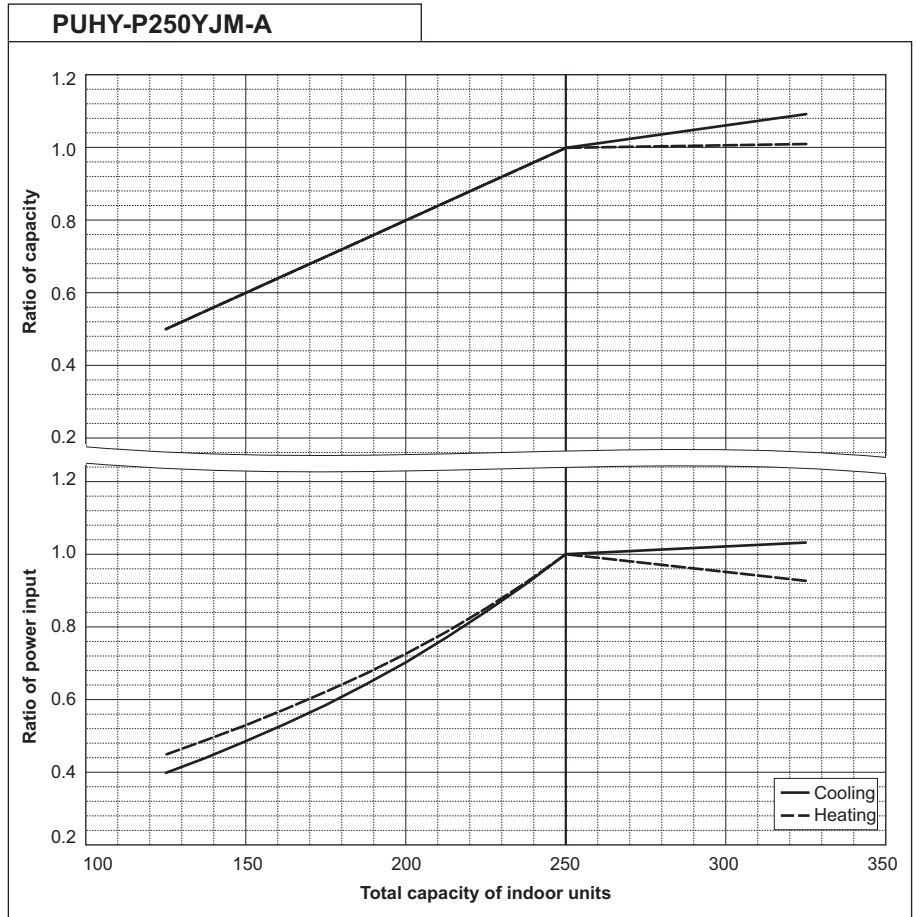

Y

PUHY-P300YJM-A		
Nominal Cooling Capacity	kW	33.5
	BTU/h	114,300
Input	kW	9.00

PUHY-P300YJM-A		
Nominal Heating Capacity	kW	37.5
	BTU/h	128,000
Input	kW	9.25

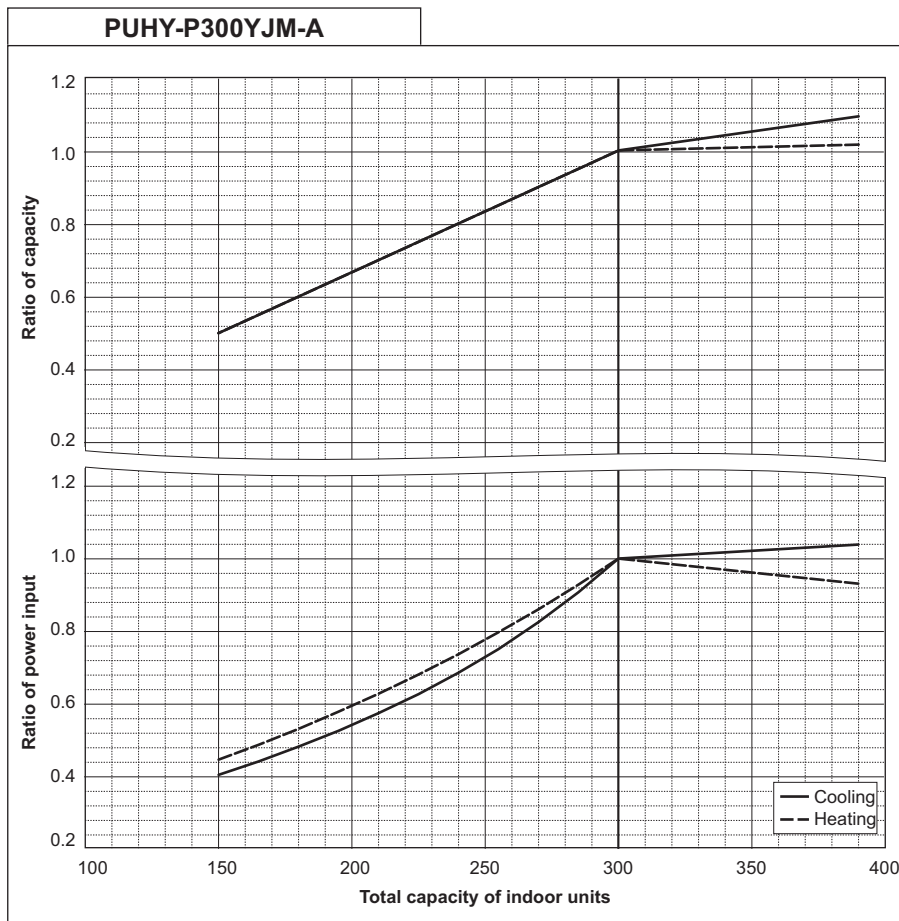

PUHY-P350YJM-A		
Nominal Cooling Capacity	kW	40.0
	BTU/h	136,500
Input	kW	11.01

PUHY-P350YJM-A		
Nominal Heating Capacity	kW	45.0
	BTU/h	153,500
Input	kW	11.19

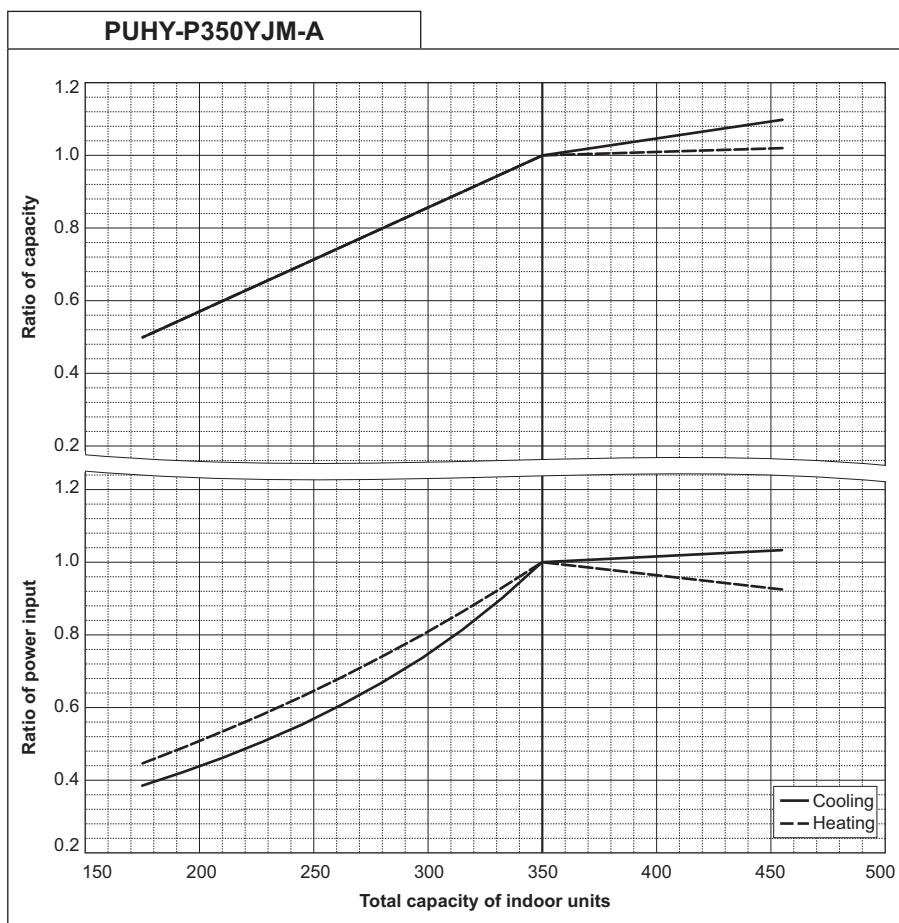

PUHY-P400YJM-A		
Nominal Cooling Capacity	kW	45.0
	BTU/h	153,500
Input	kW	13.11

PUHY-P400YJM-A		
Nominal Heating Capacity	kW	50.0
	BTU/h	170,600
Input	kW	12.82

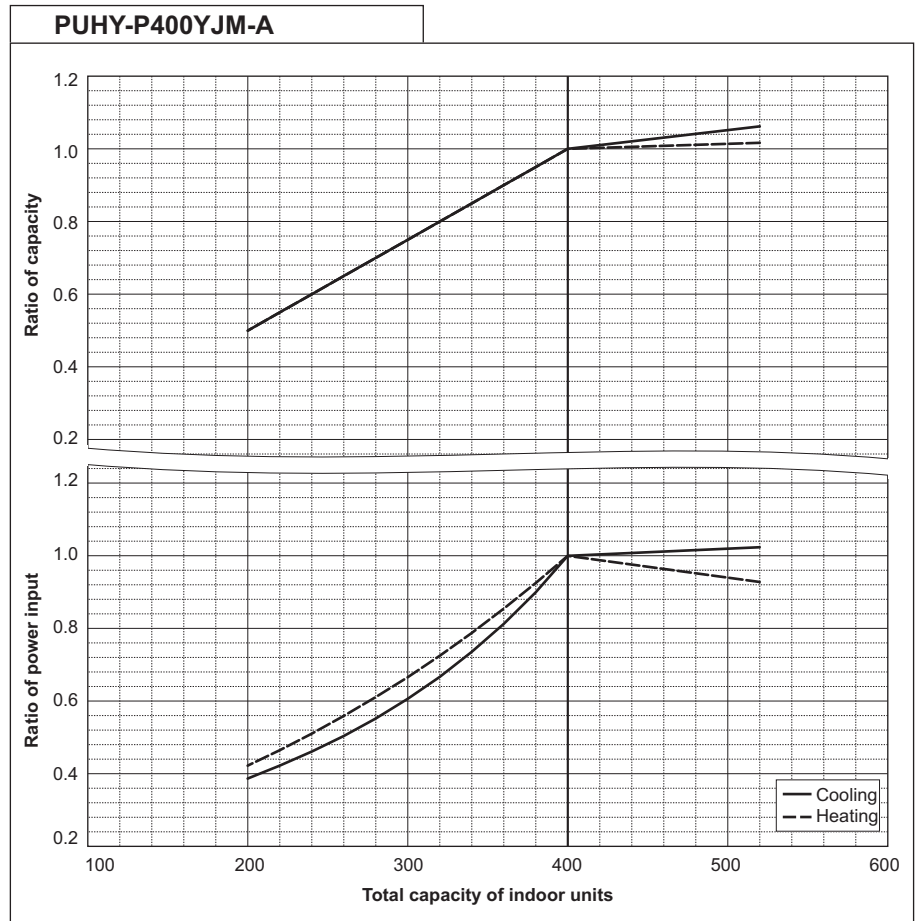

PUHY-P450YJM-A		
Nominal Cooling Capacity	kW	50.0
	BTU/h	170,600
Input	kW	15.47

PUHY-P450YJM-A		
Nominal Heating Capacity	kW	56.0
	BTU/h	191,100
Input	kW	14.62

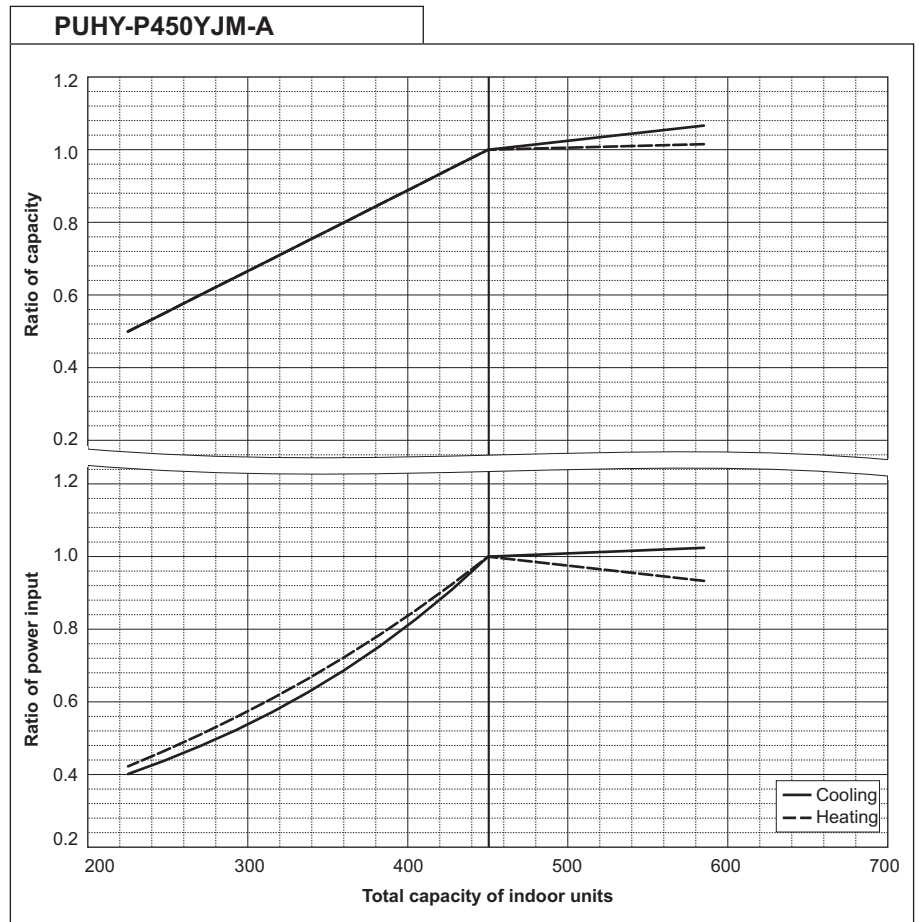

Y

PUHY-P500YSJM-A		
Nominal Cooling Capacity	kW	56.0
	BTU/h	191,100
Input	kW	15.38

PUHY-P500YSJM-A1		
Nominal Cooling Capacity	kW	56.0
	BTU/h	191,100
Input	kW	15.05

PUHY-P500YSJM-A		
Nominal Heating Capacity	kW	63.0
	BTU/h	215,000
Input	kW	15.03

PUHY-P500YSJM-A1		
Nominal Heating Capacity	kW	63.0
	BTU/h	215,000
Input	kW	15.51

PUHY-P500YSJM-A, PUHY-P500YSJM-A1

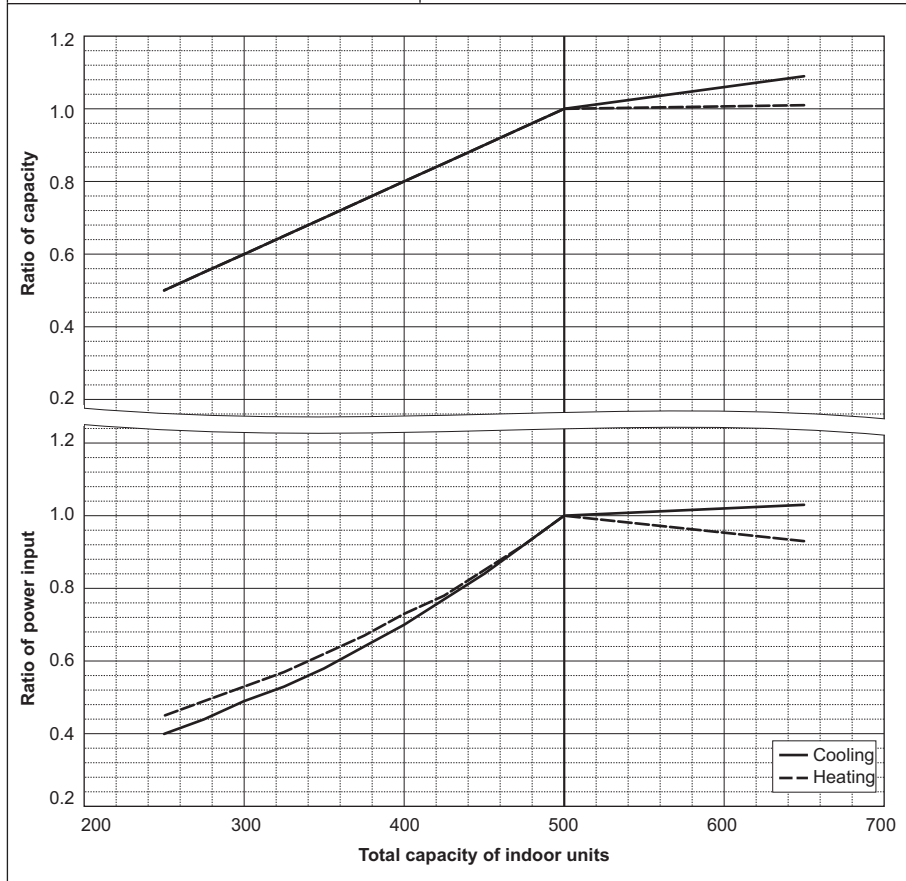

PUHY-P550YSJM-A		
Nominal Cooling Capacity	kW	63.0
	BTU/h	215,000
Input	kW	17.16

PUHY-P550YSJM-A		
Nominal Heating Capacity	kW	69.0
	BTU/h	235,400
Input	kW	16.87

PUHY-P550YSJM-A

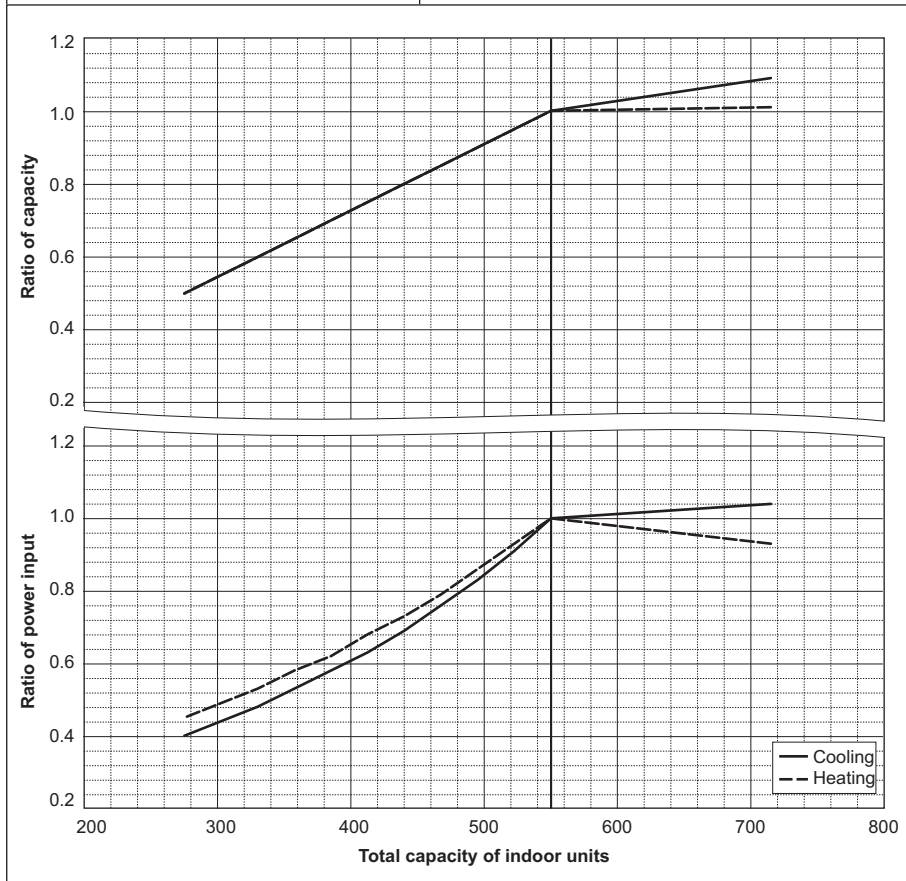

6. CAPACITY TABLES

PUHY-P600YSJM-A		
Nominal Cooling Capacity	kW	69.0
	BTU/h	235,400
Input	kW	18.75

PUHY-P600YSJM-A1		
Nominal Cooling Capacity	kW	69.0
	BTU/h	235,400
Input	kW	19.00

PUHY-P600YSJM-A		
Nominal Heating Capacity	kW	76.5
	BTU/h	261,000
Input	kW	18.88

PUHY-P600YSJM-A1		
Nominal Heating Capacity	kW	76.5
	BTU/h	261,000
Input	kW	19.26

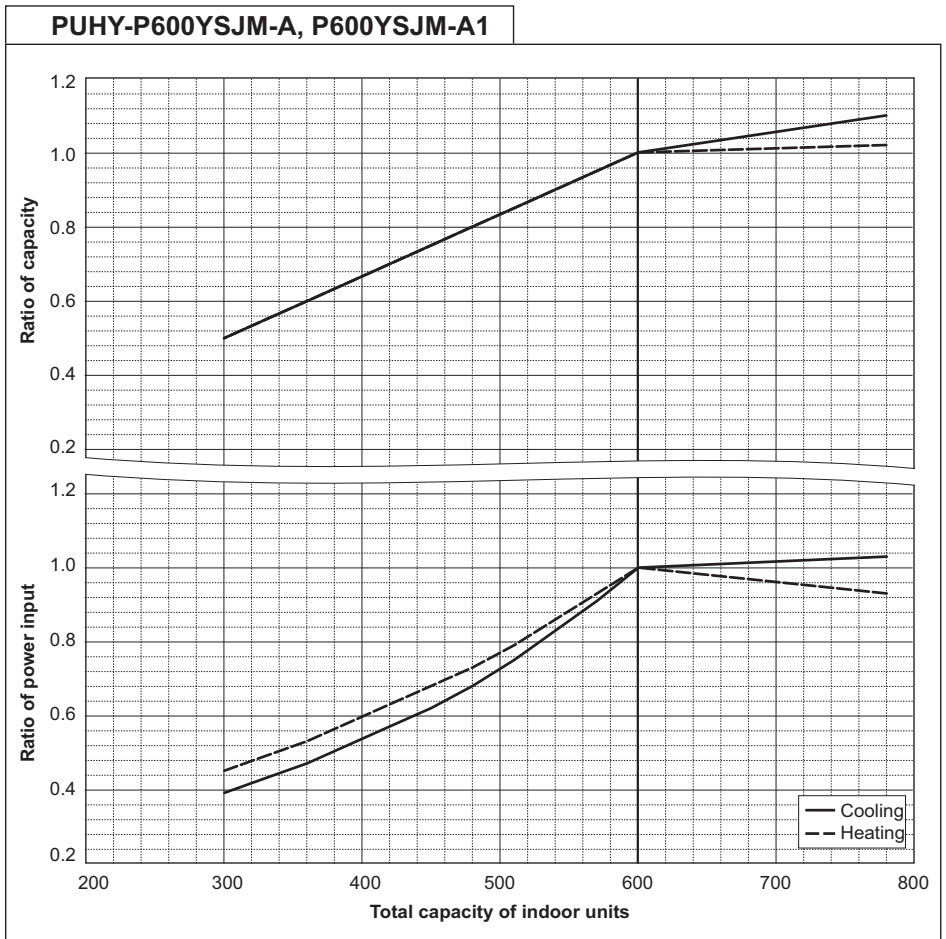

PUHY-P650YSJM-A		
Nominal Cooling Capacity	kW	73.0
	BTU/h	249,100
Input	kW	20.39

PUHY-P650YSJM-A		
Nominal Heating Capacity	kW	81.5
	BTU/h	278,100
Input	kW	20.47

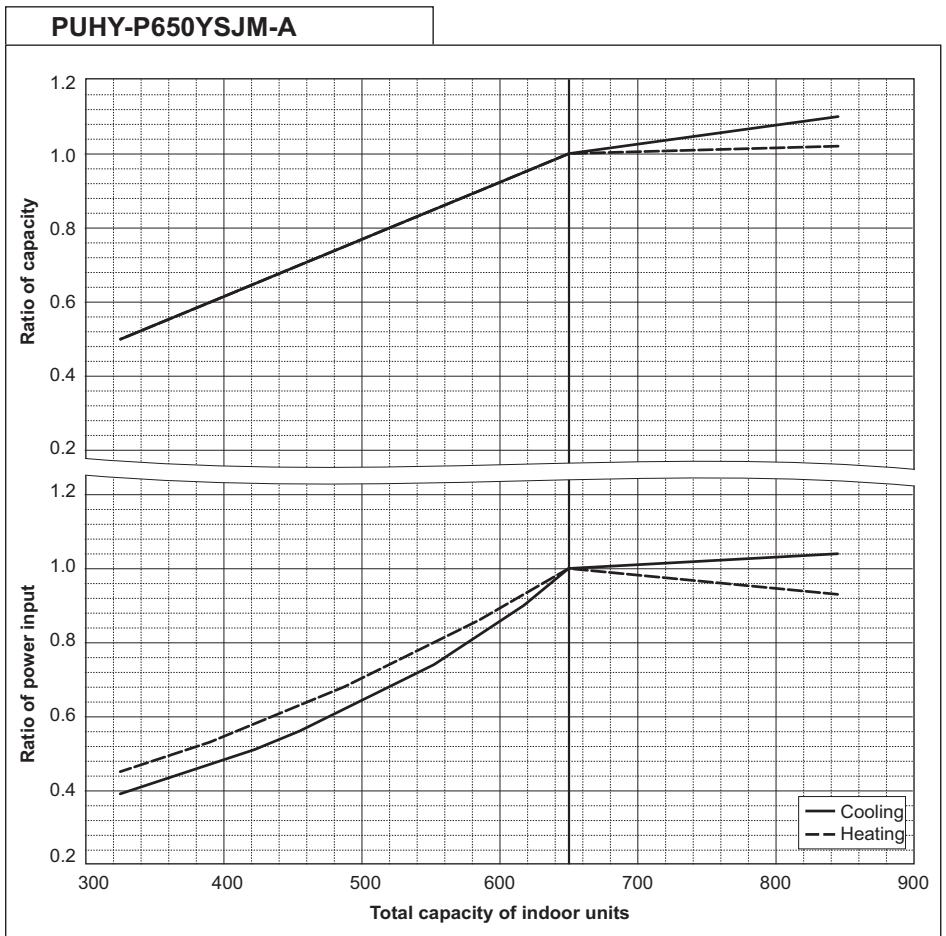

Y

PUHY-P700YSJM-A		
Nominal Cooling Capacity	kW	80.0
	BTU/h	273,000
Input	kW	22.47

PUHY-P700YSJM-A1		
Nominal Cooling Capacity	kW	80.0
	BTU/h	273,000
Input	kW	23.05

PUHY-P700YSJM-A		
Nominal Heating Capacity	kW	88.0
	BTU/h	300,300
Input	kW	22.27

PUHY-P700YSJM-A1		
Nominal Heating Capacity	kW	88.0
	BTU/h	300,300
Input	kW	23.09

PUHY-P700YSJM-A, PUHY-P700YSJM-A1

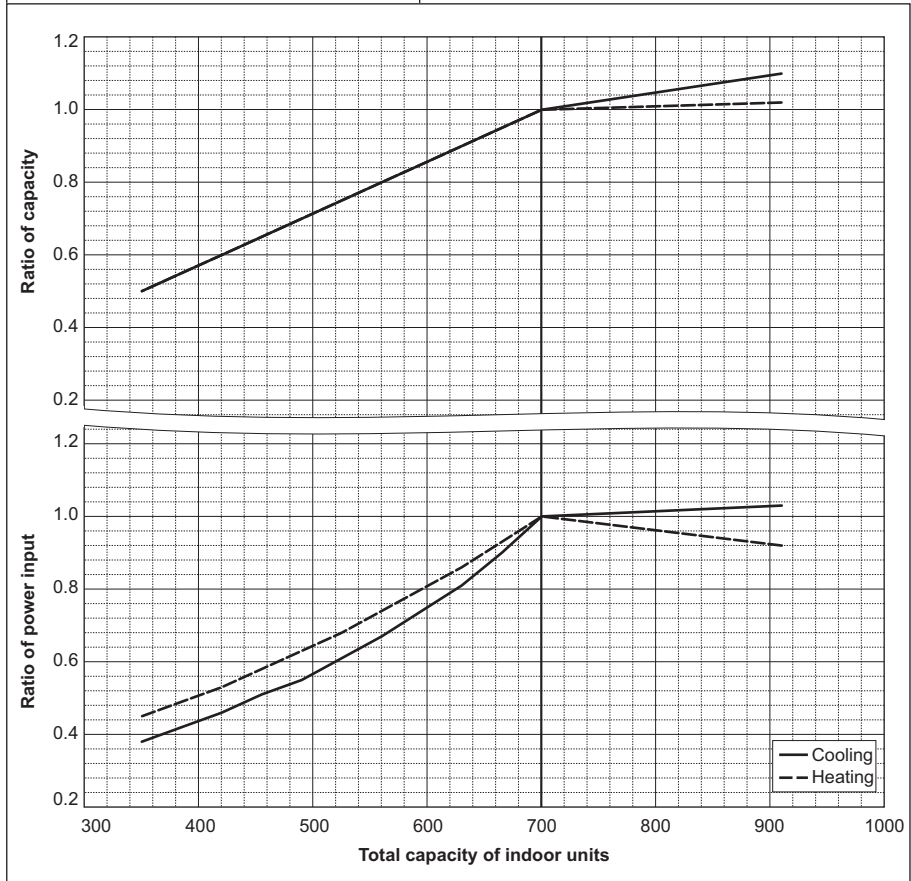

PUHY-P750YSJM-A		
Nominal Cooling Capacity	kW	85.0
	BTU/h	290,000
Input	kW	24.70

PUHY-P750YSJM-A		
Nominal Heating Capacity	kW	95.0
	BTU/h	324,100
Input	kW	24.67

PUHY-P750YSJM-A

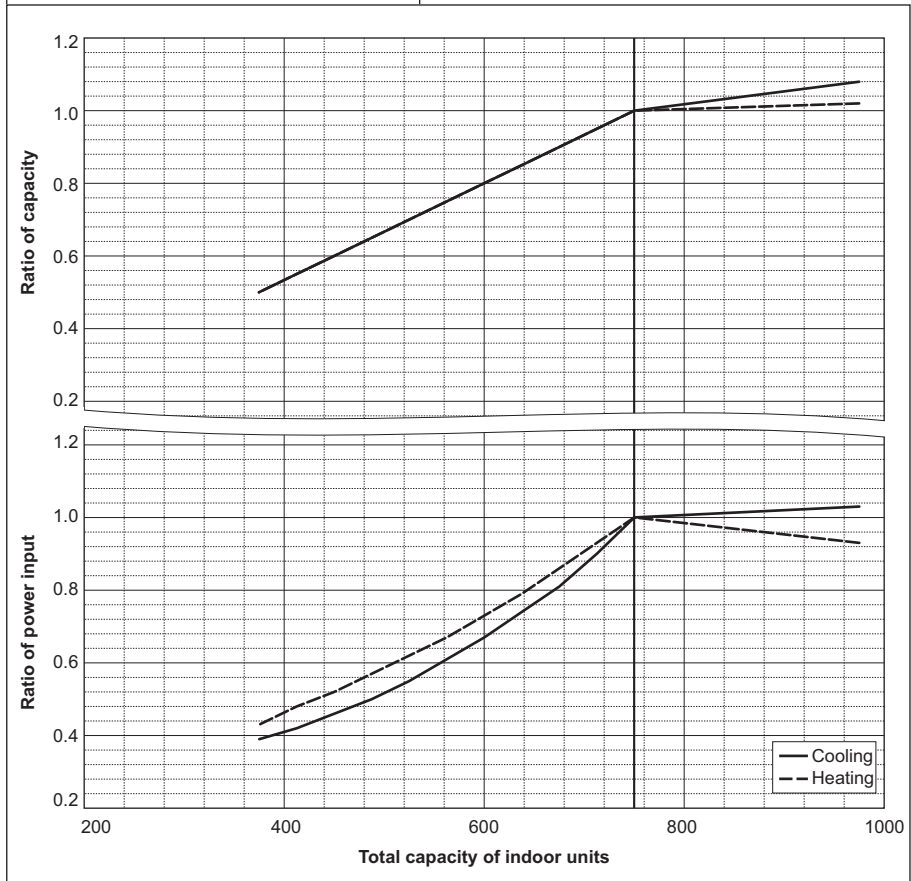

PUHY-P800YSJM-A		
Nominal Cooling Capacity	kW	90.0
	BTU/h	307,100
Input	kW	27.10

PUHY-P800YSJM-A1		
Nominal Cooling Capacity	kW	90.0
	BTU/h	307,100
Input	kW	26.86

PUHY-P800YSJM-A		
Nominal Heating Capacity	kW	100.0
	BTU/h	341,200
Input	kW	25.70

PUHY-P800YSJM-A1		
Nominal Heating Capacity	kW	100.0
	BTU/h	341,200
Input	kW	27.02

PUHY-P800YSJM-A, P800YSJM-A1

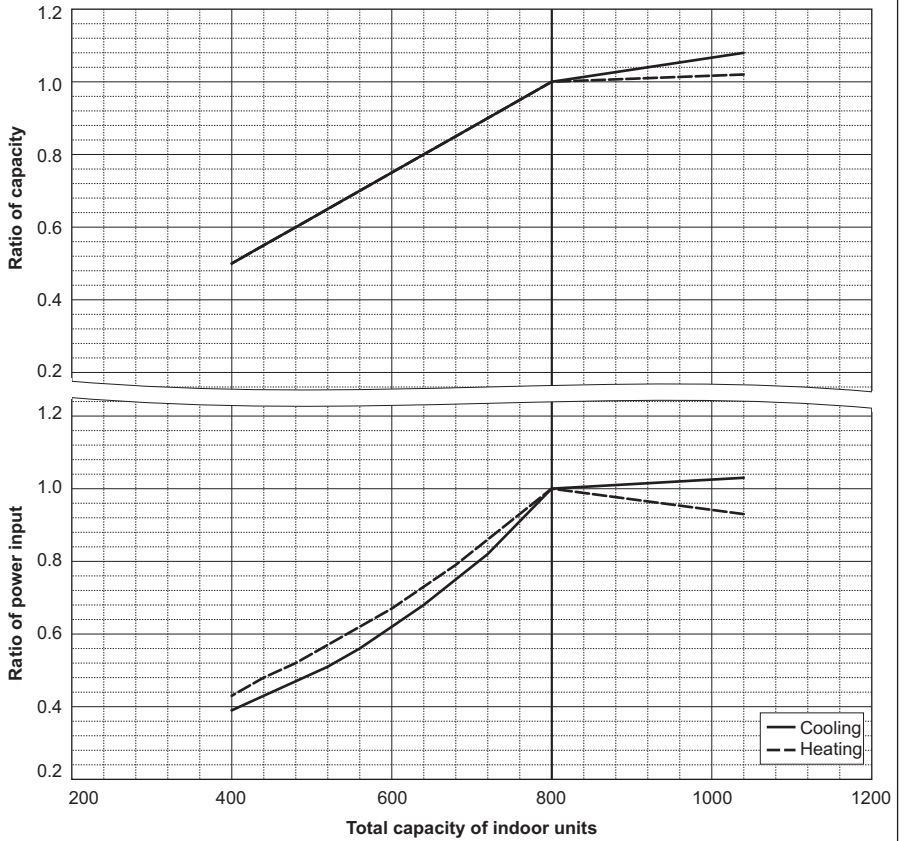

PUHY-P850YSJM-A		
Nominal Cooling Capacity	kW	96.0
	BTU/h	327,600
Input	kW	29.62

PUHY-P850YSJM-A		
Nominal Heating Capacity	kW	108.0
	BTU/h	368,500
Input	kW	28.42

PUHY-P850YSJM-A

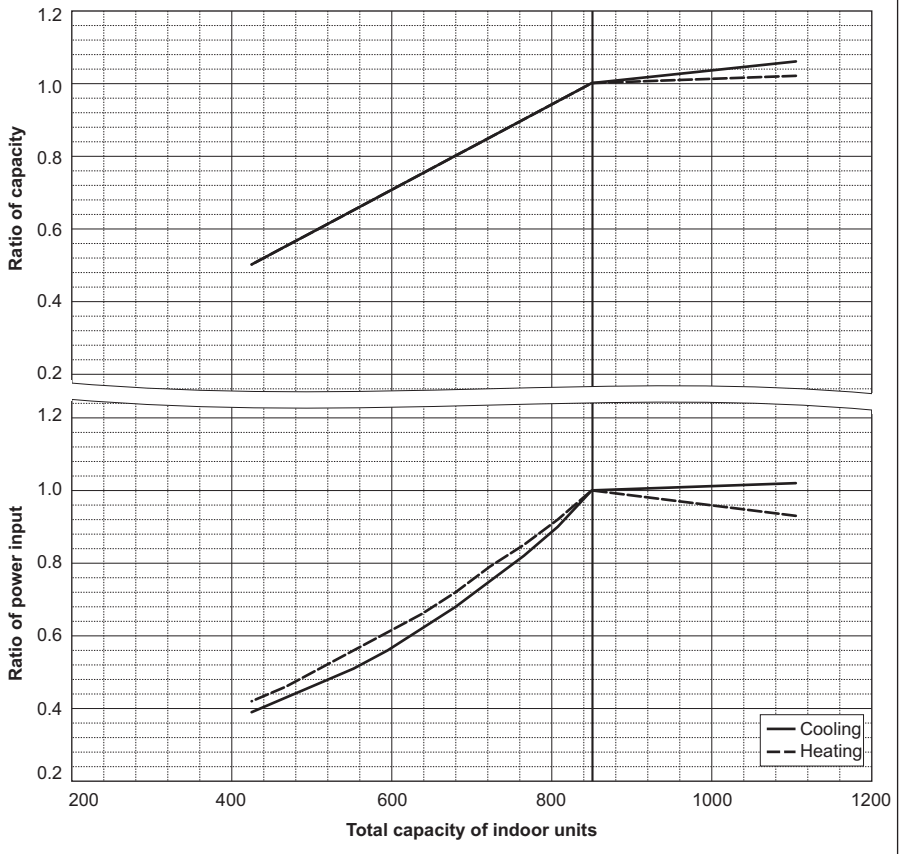

Y

PUHY-P900YSJM-A		
Nominal Cooling Capacity	kW	101.0
	BTU/h	344,600
Input	kW	32.06

PUHY-P900YSJM-A		
Nominal Heating Capacity	kW	113.0
	BTU/h	385,600
Input	kW	30.05

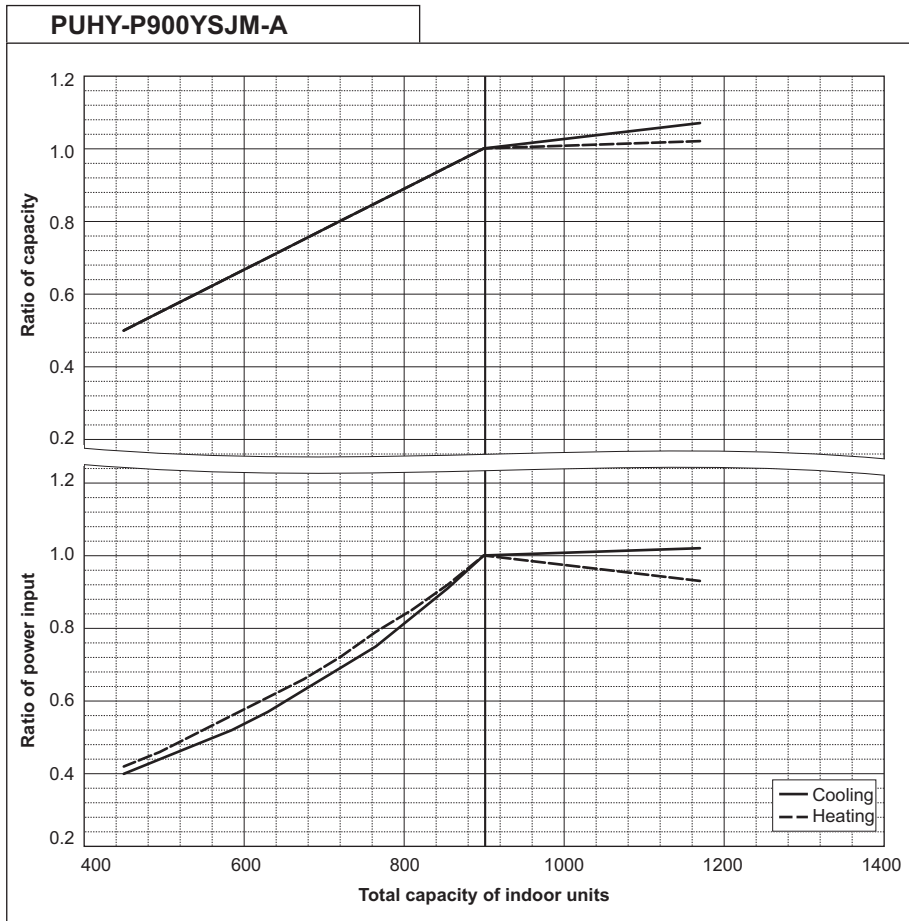

PUHY-P950YSJM-A		
Nominal Cooling Capacity	kW	108.0
	BTU/h	368,500
Input	kW	30.50

PUHY-P950YSJM-A		
Nominal Heating Capacity	kW	119.5
	BTU/h	407,700
Input	kW	30.02

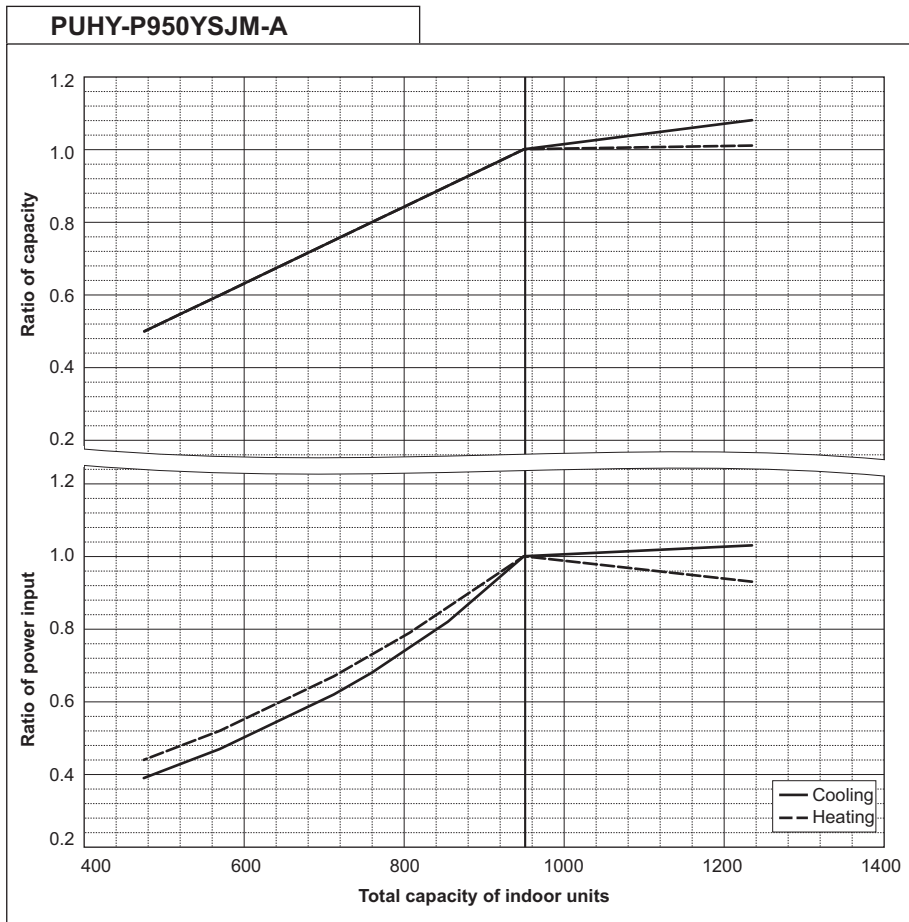

PUHY-P1000YSJM-A		
Nominal Cooling Capacity	kW	113.0
	BTU/h	385,600
Input	kW	32.10

PUHY-P1000YSJM-A		
Nominal Heating Capacity	kW	127.0
	BTU/h	433,300
Input	kW	33.15

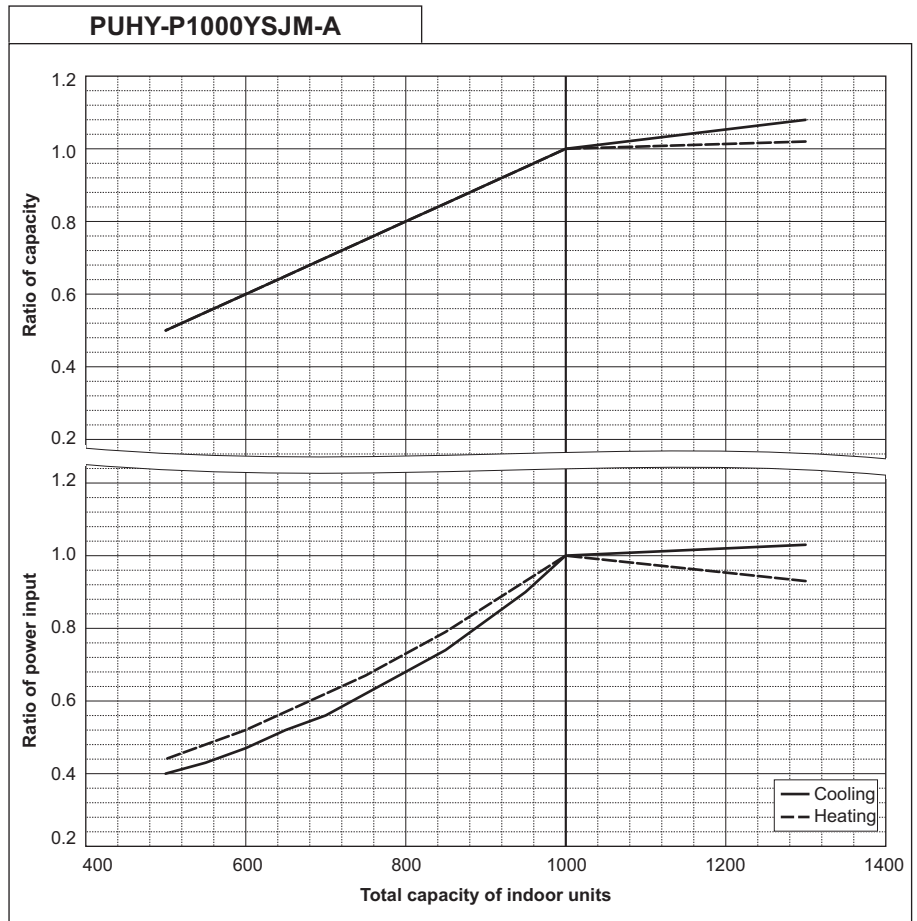

PUHY-P1050YSJM-A		
Nominal Cooling Capacity	kW	118.0
	BTU/h	402,600
Input	kW	33.81

PUHY-P1050YSJM-A		
Nominal Heating Capacity	kW	132.0
	BTU/h	450,400
Input	kW	34.10

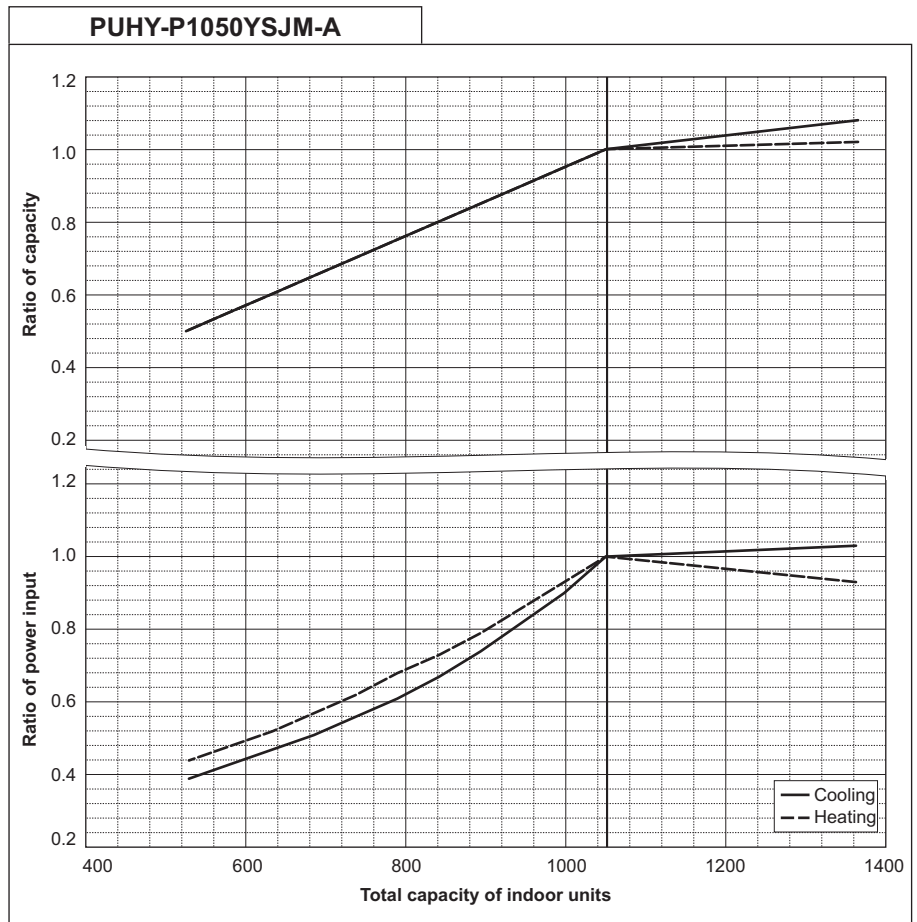

6. CAPACITY TABLES

Y

PUHY-P1100YSJM-A		
Nominal Cooling Capacity	kW	124.0
	BTU/h	423,100
Input	kW	35.73

PUHY-P1100YSJM-A		
Nominal Heating Capacity	kW	140.0
	BTU/h	477,700
Input	kW	36.08

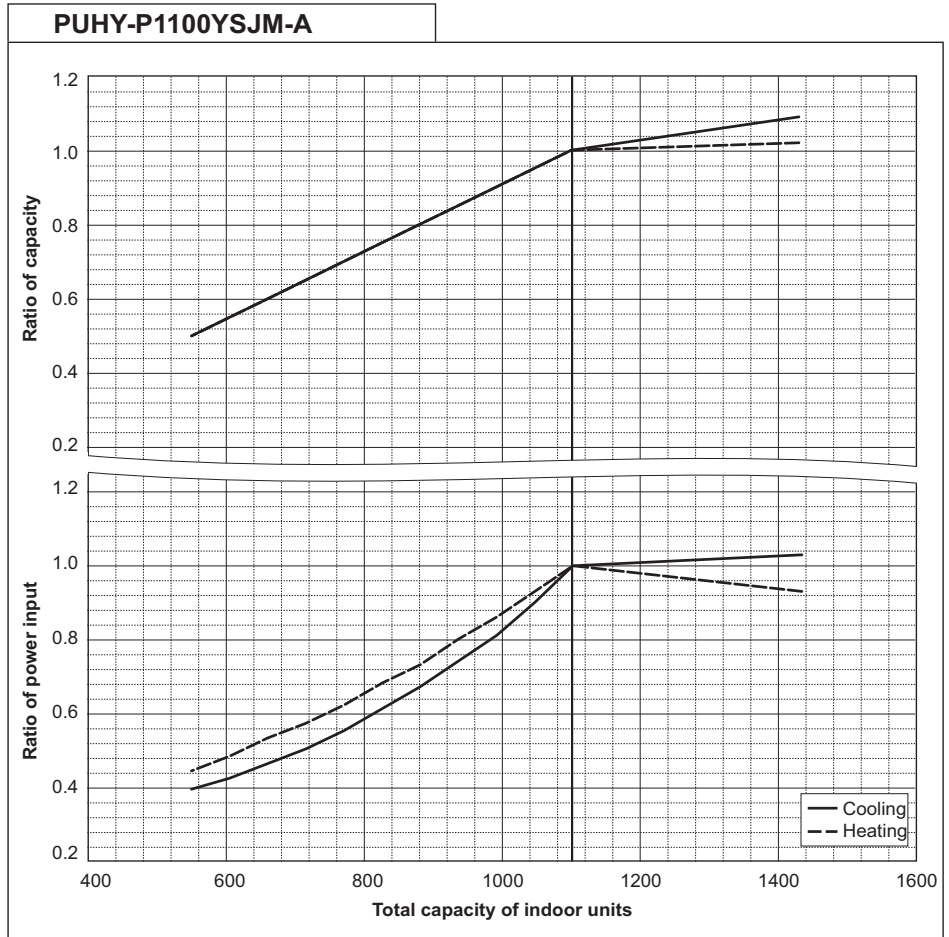

PUHY-P1150YSJM-A		
Nominal Cooling Capacity	kW	130.0
	BTU/h	443,600
Input	kW	38.34

PUHY-P1150YSJM-A		
Nominal Heating Capacity	kW	145.0
	BTU/h	494,700
Input	kW	37.27

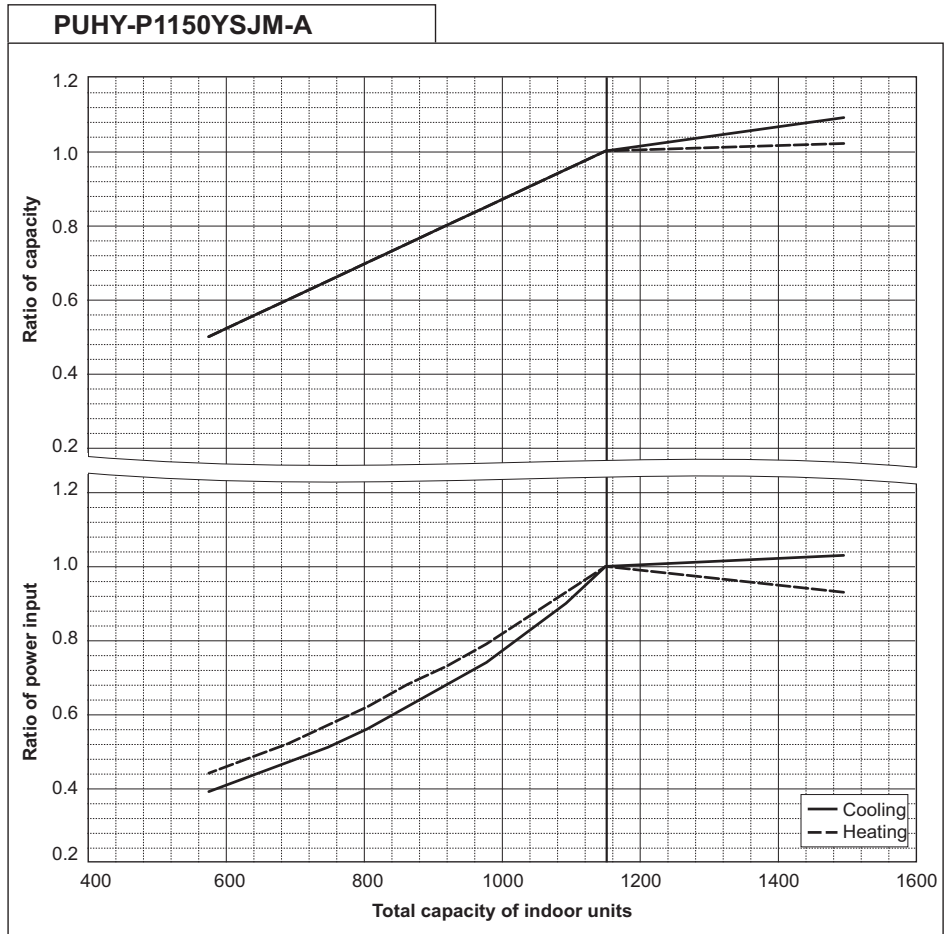

PUHY-P1200YSJM-A		
Nominal Cooling Capacity	kW	136.0
	BTU/h	464,000
Input	kW	40.84

PUHY-P1200YSJM-A		
Nominal Heating Capacity	kW	150.0
	BTU/h	511,800
Input	kW	39.26

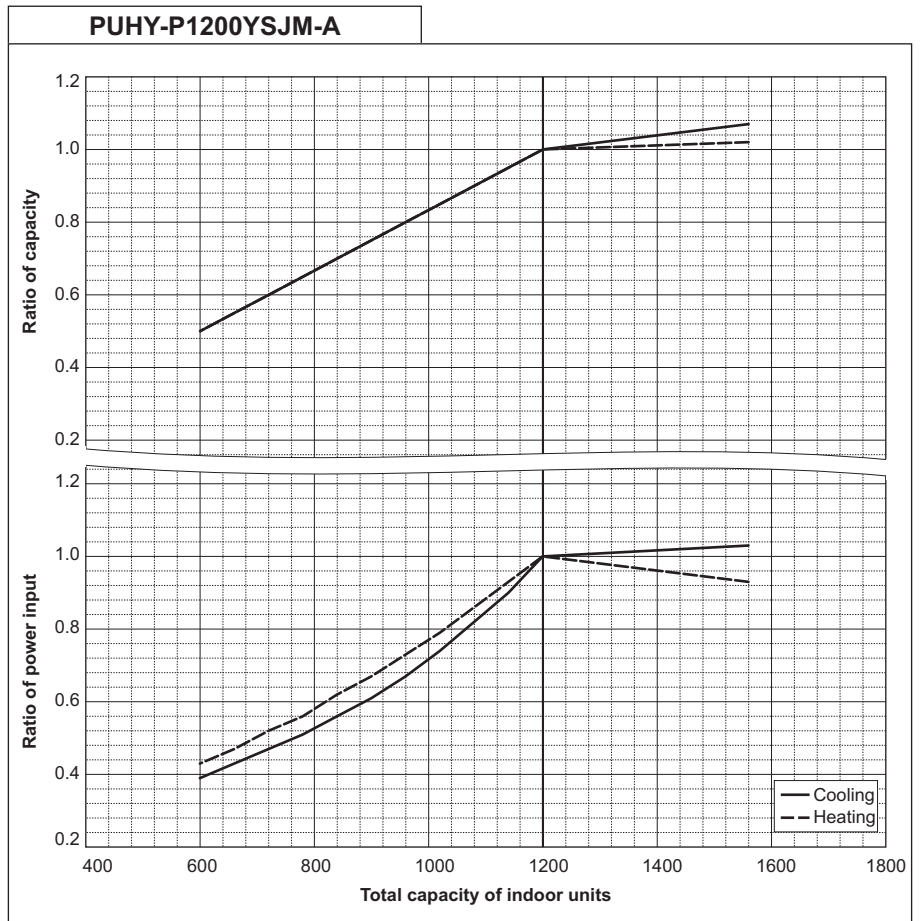

PUHY-P1250YSJM-A		
Nominal Cooling Capacity	kW	140.0
	BTU/h	477,700
Input	kW	42.94

PUHY-P1250YSJM-A		
Nominal Heating Capacity	kW	156.5
	BTU/h	534,000
Input	kW	40.86

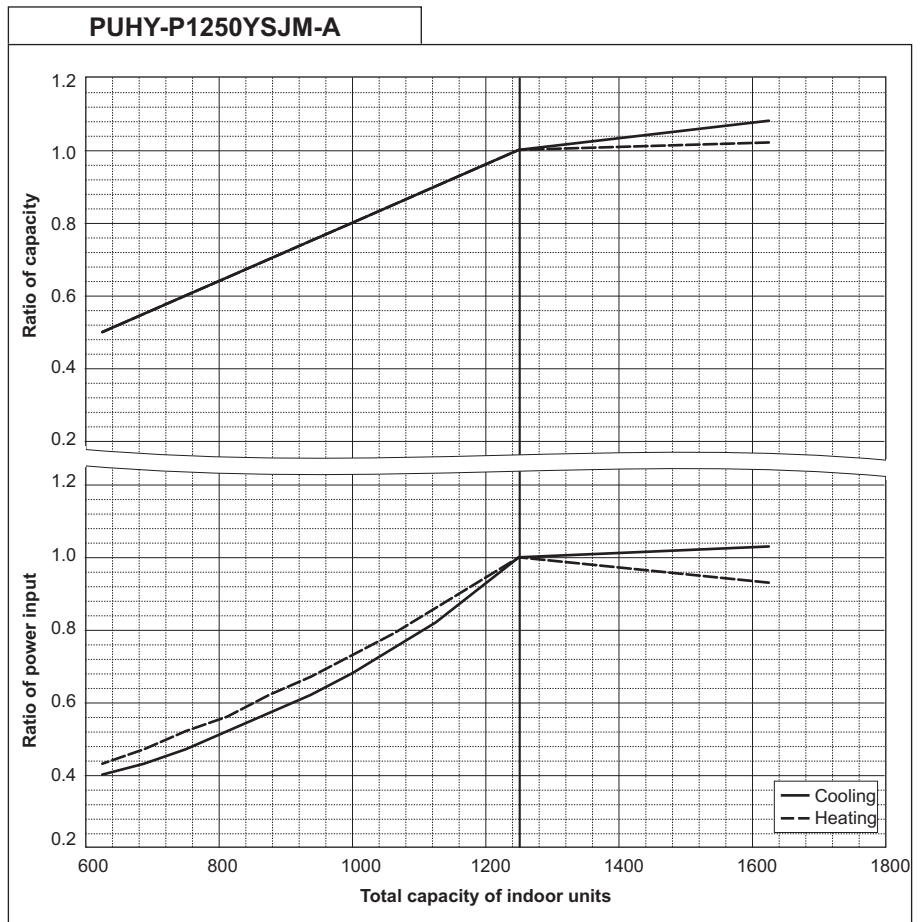

6-3. Correction by refrigerant piping length

CITY MULTI system can extend the piping flexibly within its limitation for the actual situation. Yet, a decrease of cooling/heating capacity could happen correspondently. Using following correction factor according to the equivalent length of the piping shown at 6-3-1 and 6-3-2, the capacity can be observed. 6-3-3 shows how to obtain the equivalent length of piping.

6-3-1. Cooling capacity correction

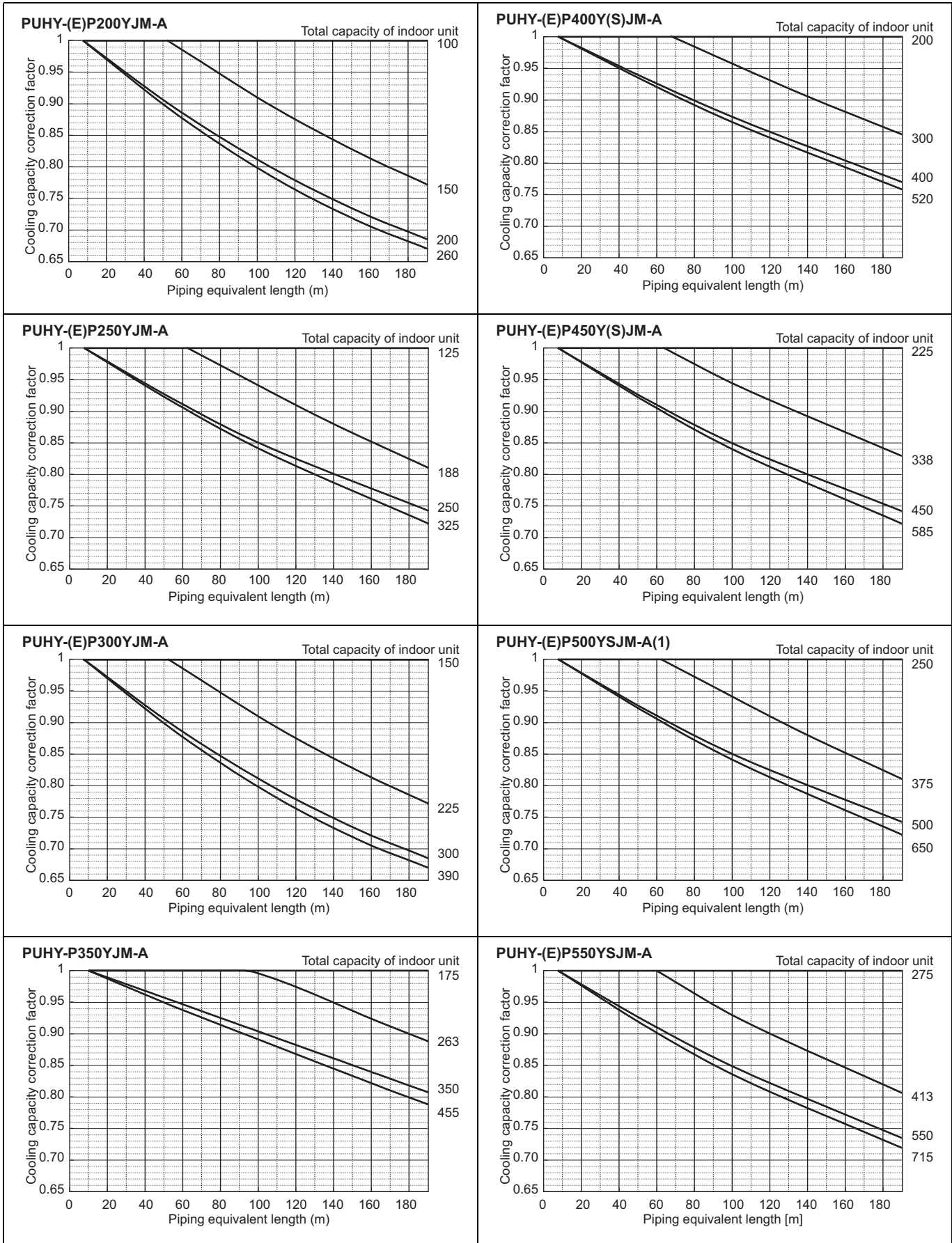

6. CAPACITY TABLES

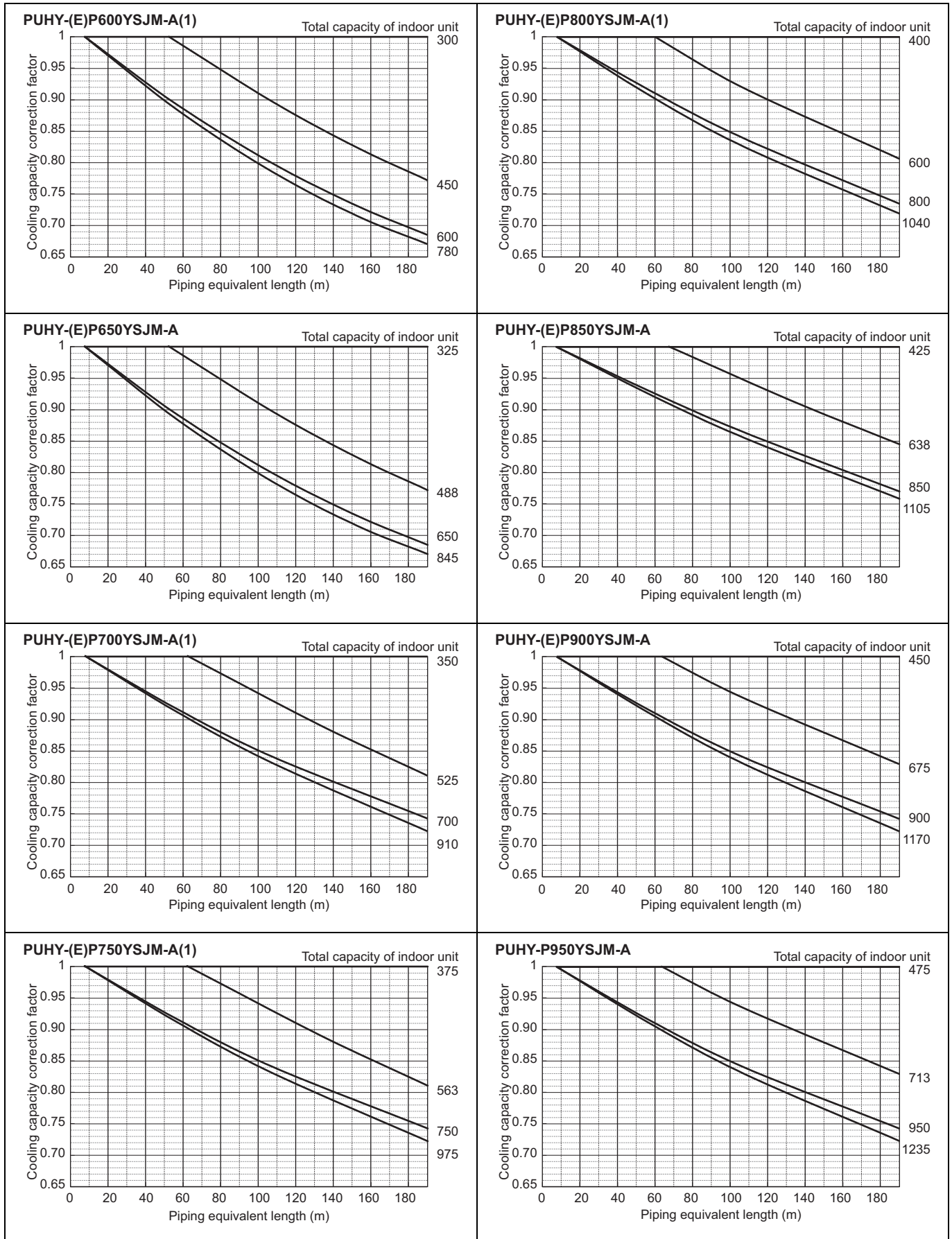

6. CAPACITY TABLES

Y

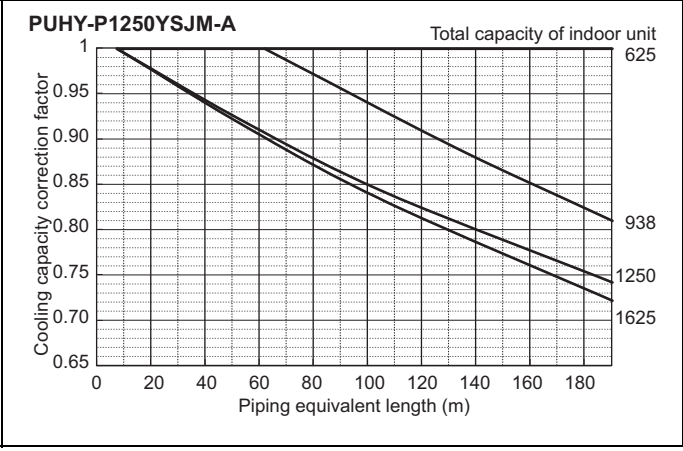
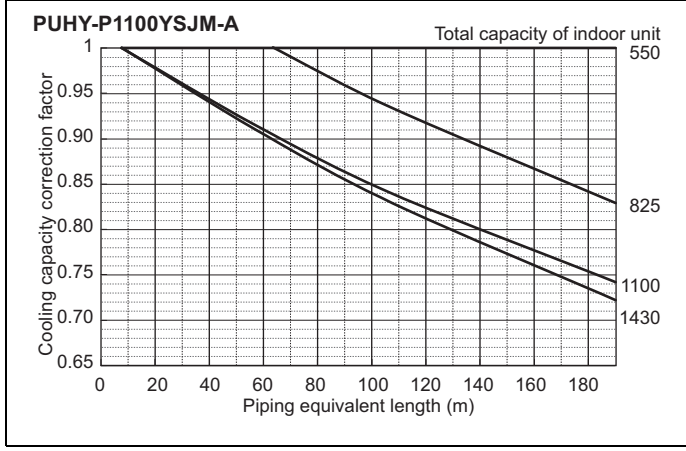
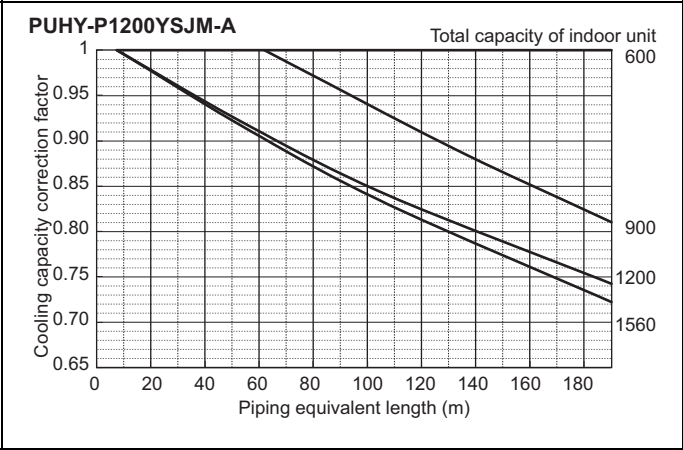
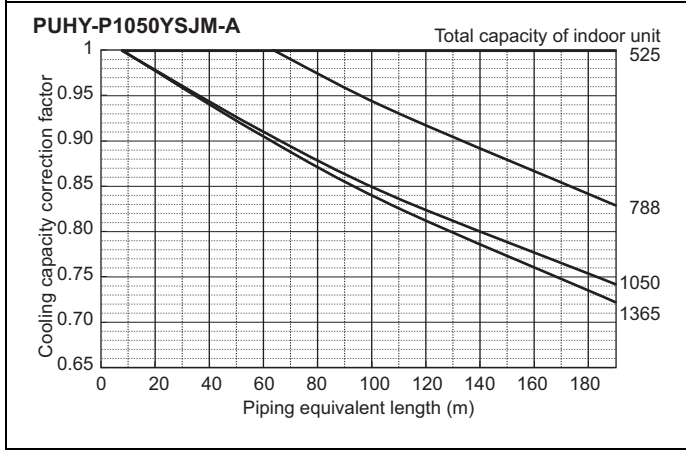
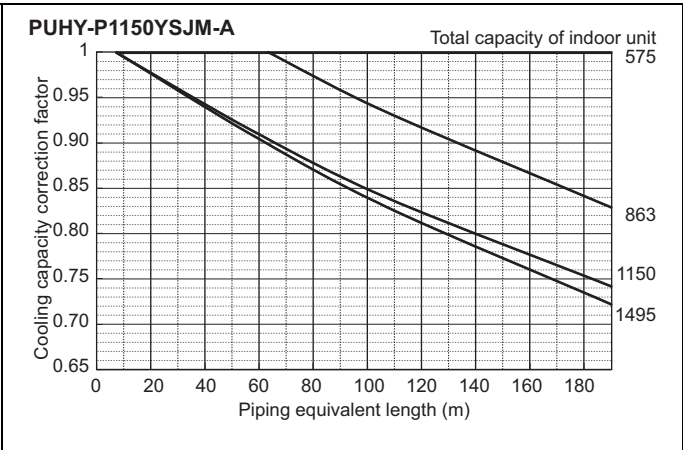
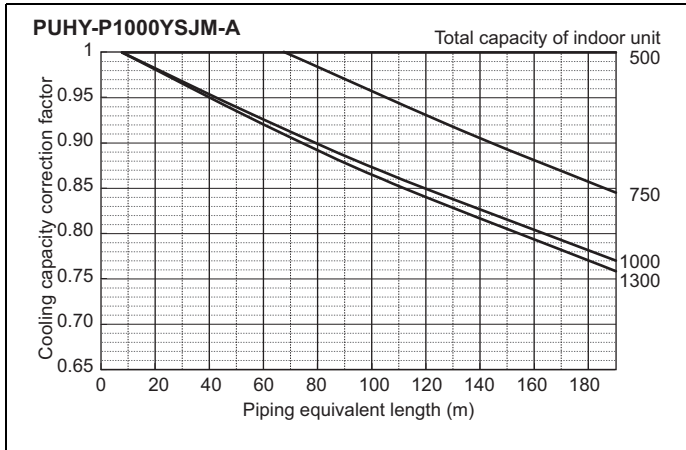

6-3-2. Heating capacity correction

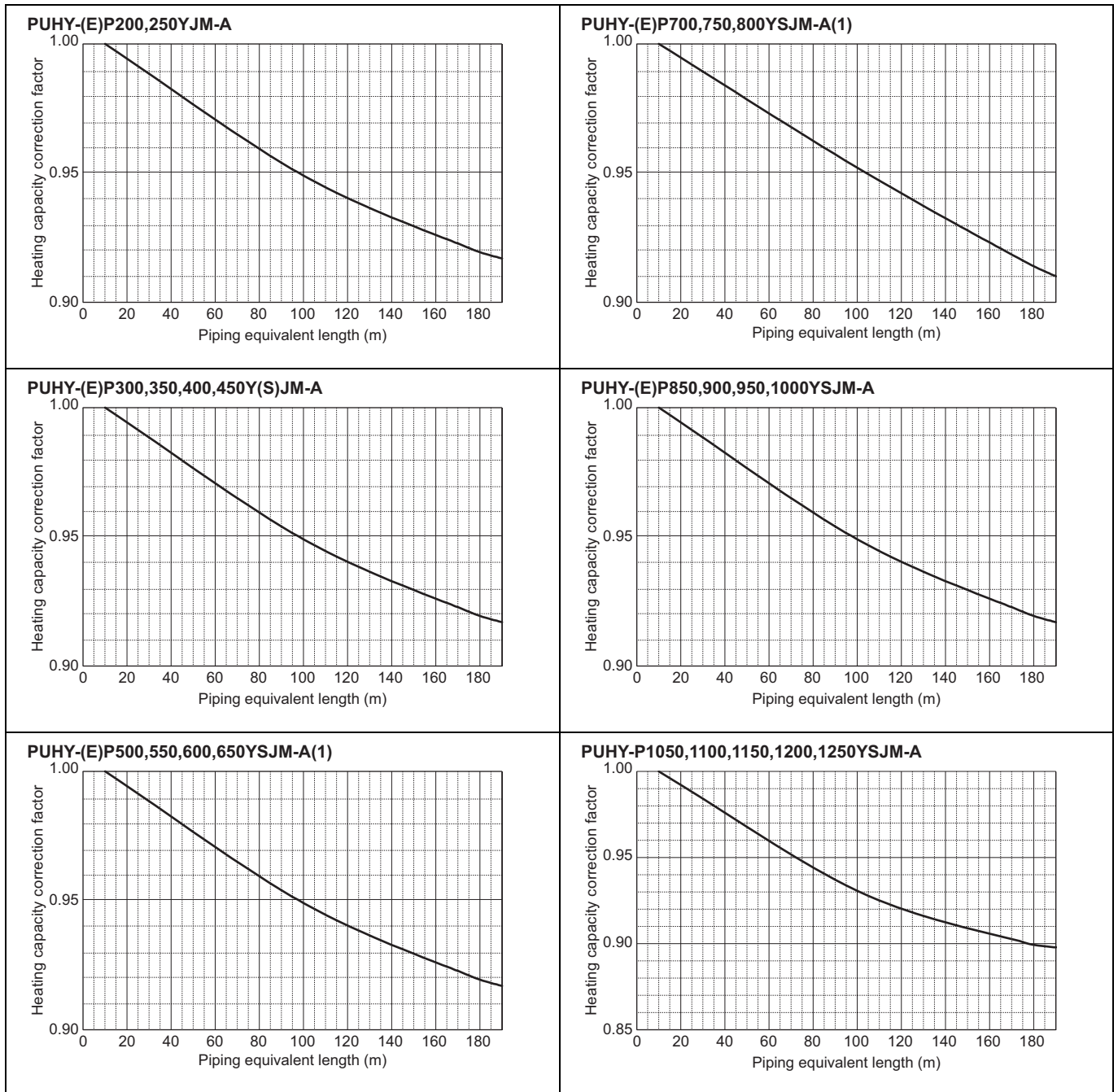

6-3-3. How to obtain the equivalent piping length

- 1 **PUHY-(E)P200YJM**
Equivalent length = (Actual piping length to the farthest indoor unit) + (0.35 x number of bends in the piping) m
- 2 **PUHY-(E)P250,300YJM**
Equivalent length = (Actual piping length to the farthest indoor unit) + (0.42 x number of bends in the piping) m
- 3 **PUHY-P350YJM**
Equivalent length = (Actual piping length to the farthest indoor unit) + (0.47 x number of bends in the piping) m
- 4 **PUHY-(E)P400,450,500,550,600,650Y(S)JM**
Equivalent length = (Actual piping length to the farthest indoor unit) + (0.50 x number of bends in the piping) m
- 5 **PUHY-(E)P700,750,800YSJM**
Equivalent length = (Actual piping length to the farthest indoor unit) + (0.70 x number of bends in the piping) m
- 6 **PUHY-(E)P850,900,950,1000,1050,1100,1150,1200,1250YSJM**
Equivalent length = (Actual piping length to the farthest indoor unit) + (0.80 x number of bends in the piping) m

6-4. Correction at frost and defrost

Due to frost at the outdoor heat exchanger and the automatic defrost operation, the heating capacity of the outdoor unit can be calculated by multiplying the correction factor shown in the table below.

Table of correction factor at frost and defrost

Outdoor inlet air temp. °C	6	4	2	1	0	-2	-4	-6	-8	-10	-20
Outdoor inlet air temp. °F	43	39	36	34	32	28	25	21	18	14	-4
PUHY-(E)P200YJM-A (-BS)	1.00	0.95	0.84	0.825	0.83	0.87	0.90	0.95	0.95	0.95	0.95
PUHY-(E)P250YJM-A (-BS)	1.00	0.95	0.84	0.825	0.83	0.87	0.90	0.95	0.95	0.95	0.95
PUHY-(E)P300YJM-A (-BS)	1.00	0.93	0.82	0.80	0.82	0.86	0.90	0.90	0.95	0.95	0.95
PUHY-P350YJM-A (-BS)	1.00	0.93	0.85	0.83	0.84	0.86	0.90	0.90	0.95	0.95	0.95
PUHY-(E)P400YJM-A (-BS)	1.00	0.95	0.90	0.87	0.88	0.89	0.90	0.95	0.95	0.95	0.95
PUHY-(E)P450YJM-A (-BS)	1.00	0.98	0.89	0.87	0.89	0.90	0.92	0.95	0.95	0.95	0.95
PUHY-(E)P500YSJM-A(1) (-BS)	1.00	0.98	0.89	0.86	0.89	0.90	0.92	0.95	0.95	0.95	0.95
PUHY-(E)P550YSJM-A (-BS)	1.00	0.94	0.87	0.86	0.87	0.88	0.90	0.90	0.93	0.93	0.93
PUHY-(E)P600YSJM-A(1) (-BS)	1.00	0.94	0.87	0.86	0.87	0.88	0.90	0.90	0.93	0.93	0.93
PUHY-(E)P650YSJM-A (-BS)	1.00	0.94	0.87	0.86	0.87	0.88	0.90	0.90	0.93	0.93	0.93
PUHY-(E)P700YSJM-A(1) (-BS)	1.00	0.98	0.89	0.88	0.89	0.90	0.92	0.95	0.95	0.95	0.95
PUHY-(E)P750YSJM-A (-BS)	1.00	0.98	0.89	0.88	0.89	0.90	0.92	0.95	0.95	0.95	0.95
PUHY-(E)P800YSJM-A(1) (-BS)	1.00	0.98	0.89	0.88	0.89	0.90	0.92	0.95	0.95	0.95	0.95
PUHY-(E)P850YSJM-A (-BS)	1.00	0.94	0.87	0.86	0.87	0.88	0.90	0.90	0.93	0.93	0.93
PUHY-(E)P900YSJM-A (-BS)	1.00	0.94	0.87	0.86	0.87	0.88	0.90	0.90	0.93	0.93	0.93
PUHY-P950YSJM-A (-BS)	1.00	0.94	0.87	0.86	0.87	0.88	0.90	0.90	0.93	0.93	0.93
PUHY-P1000YSJM-A (-BS)	1.00	0.94	0.87	0.86	0.87	0.88	0.90	0.90	0.93	0.93	0.93
PUHY-P1050YSJM-A(-BS)	1.00	0.94	0.87	0.86	0.87	0.88	0.90	0.90	0.93	0.93	0.93
PUHY-P1100YSJM-A(-BS)	1.00	0.94	0.87	0.86	0.87	0.88	0.90	0.90	0.93	0.93	0.93
PUHY-P1150YSJM-A(-BS)	1.00	0.94	0.87	0.86	0.87	0.88	0.90	0.90	0.93	0.93	0.93
PUHY-P1200YSJM-A(-BS)	1.00	0.94	0.87	0.86	0.87	0.88	0.90	0.90	0.93	0.93	0.93
PUHY-P1250YSJM-A(-BS)	1.00	0.94	0.87	0.86	0.87	0.88	0.90	0.90	0.93	0.93	0.93

6-5. Operation temperature range

• Cooling

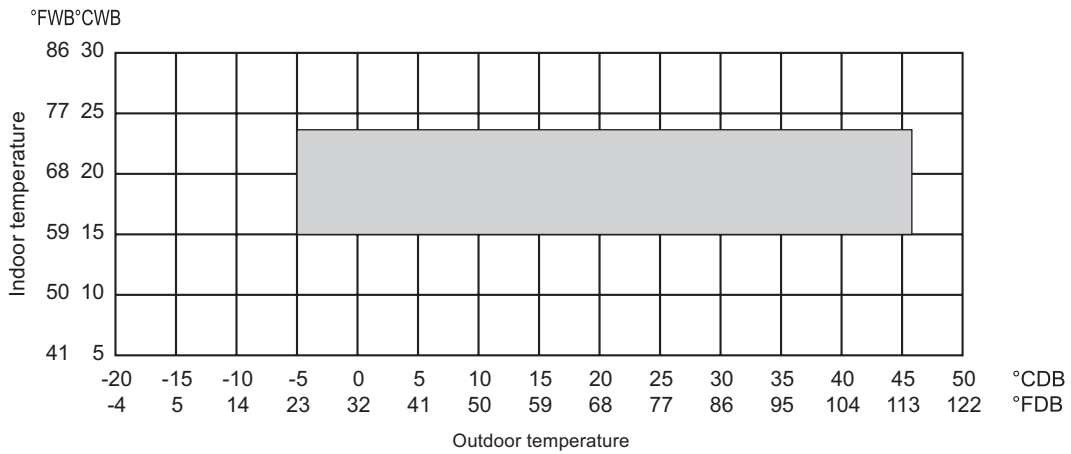

• Heating

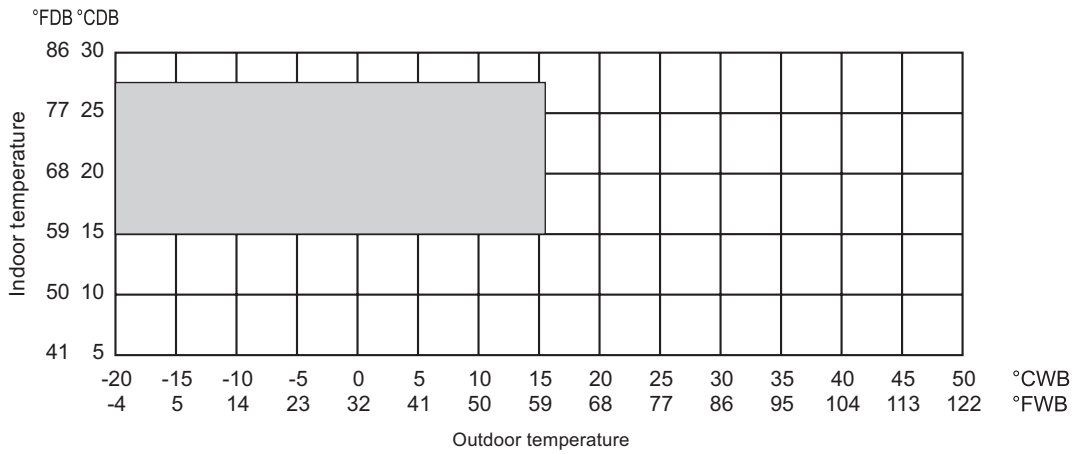

7-1. JOINT

Piping for CITY MULTI can be easily done with Joints and headers provided by MITSUBISHI ELECTRIC CORP. There are 4 sets of Joints selectable for piping. Details for applying the Joint sets are referable to System Design 3, or their own Installation Manual.

CMY-Y102S-G2 Ref.: CMY_Y102S_G2_EXD_EUDB_SI
mm

For Gas pipe: For Liquid pipe:

<Deformed pipe(Accessory)>

<Deformed pipe(Accessory)>

ID: Inner Diameter OD: Outer Diameter

CMY-Y102L-G2 Ref.: CMY_Y102L_G2_EXD_EUDB_SI
mm

For Gas pipe: For Liquid pipe:

<Deformed pipe(Accessory)>

<Deformed pipe(Accessory)>

ID: Inner Diameter OD: Outer Diameter

CMY-Y202-G2 Ref.: CMY_Y202_G2_EXD_EUDB_SI
mm

For Gas pipe: For Liquid pipe:

<Deformed pipe(Accessory)>

<Deformed pipe(Accessory)>

ID: Inner Diameter OD: Outer Diameter

CMY-Y302-G2 Ref.: CMY_Y302_G2_EXD_EUDB_SI
mm

For Gas pipe: For Liquid pipe:

<Deformed pipe(Accessory)>

<Deformed pipe(Accessory)>

ID: Inner Diameter OD: Outer Diameter

7-2. HEADER

Piping for CITY MULTI can be easily done with Joints and Headers provided by MITSUBISHI ELECTRIC CORP.

There are 3 sets of Headers selectable for piping. Details for applying the Header sets are referable to System Design 3, or their own Installation Manual.

CMY-Y104-G Ref.: CMY_Y104-G_EXD_EUDB_SI
mm

For Gas pipe:

<Deformed pipe(Accessory)>

For Liquid pipe:

<Deformed pipe(Accessory)>

ID: Inner Diameter OD: Outer Diameter
NOTE: Besides above mentioned accessories, caps for pipe of φ 6.35, φ 9.52, φ 12.7, φ 15.88 (each diameter 1 piece) are included in the Header set.

CMY-Y108-G Ref.: CMY_Y108-G_EXD_EUDB_SI
mm

For Gas pipe:

<Deformed pipe(Accessory)>

For Liquid pipe:

<Deformed pipe(Accessory)>

ID: Inner Diameter OD: Outer Diameter
NOTE: Besides above mentioned accessories, caps for pipe of φ 6.35, φ 9.52, φ 12.7, φ 15.88 (each diameter 2 pieces) and 1 cap for pipe of φ 19.05 are included in the Header set.

CMY-Y1010-G Ref.: CMY_Y1010-G_EXD_EUDB_SI
mm

For Gas pipe:

<Deformed pipe(Accessory)>

For Liquid pipe:

<Deformed pipe(Accessory)>

ID: Inner Diameter OD: Outer Diameter
NOTE: Besides above mentioned accessories, caps for pipe of φ 6.35, φ 9.52, φ 12.7, φ 15.88 (each diameter 2 pieces) and 1 cap for pipe of φ 19.05 are included in the Header set.

7-3. OUTDOOR TWINNING KIT

For PUHY-(E)P-YSJM, following optional Outdoor Twinning Kit is needed to use to combine to refrigerant flows of its PUHY-(E)P-YJM. Details of selecting the proper kit should be referred to the System Design Section.

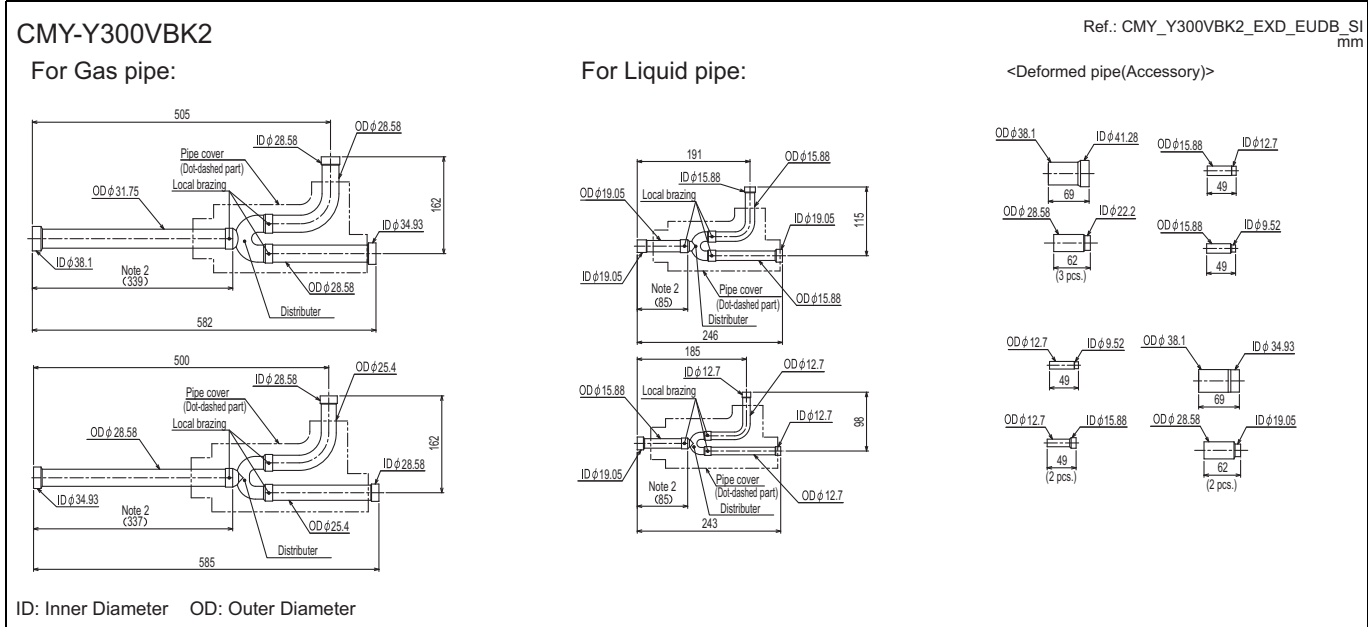
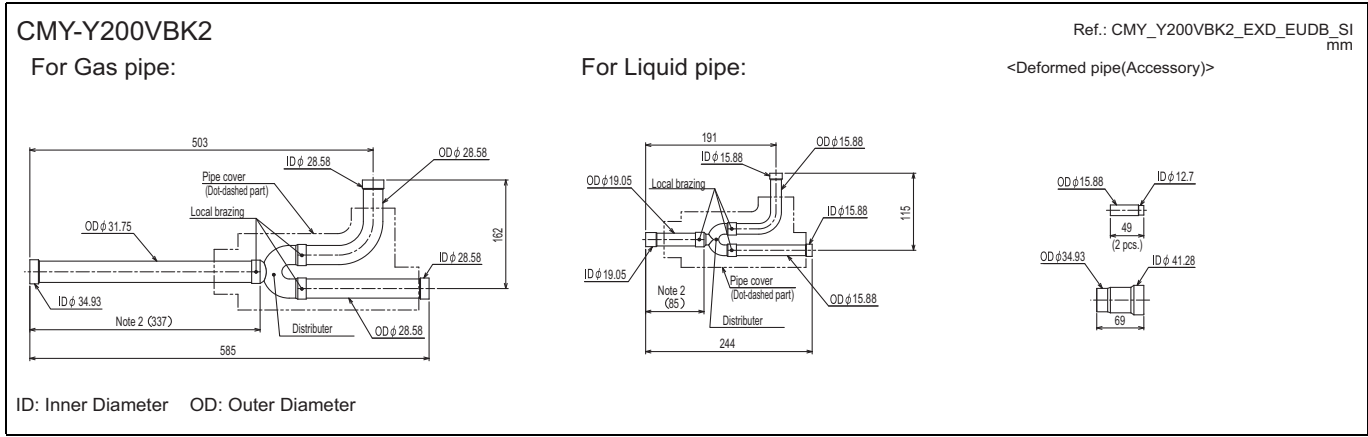
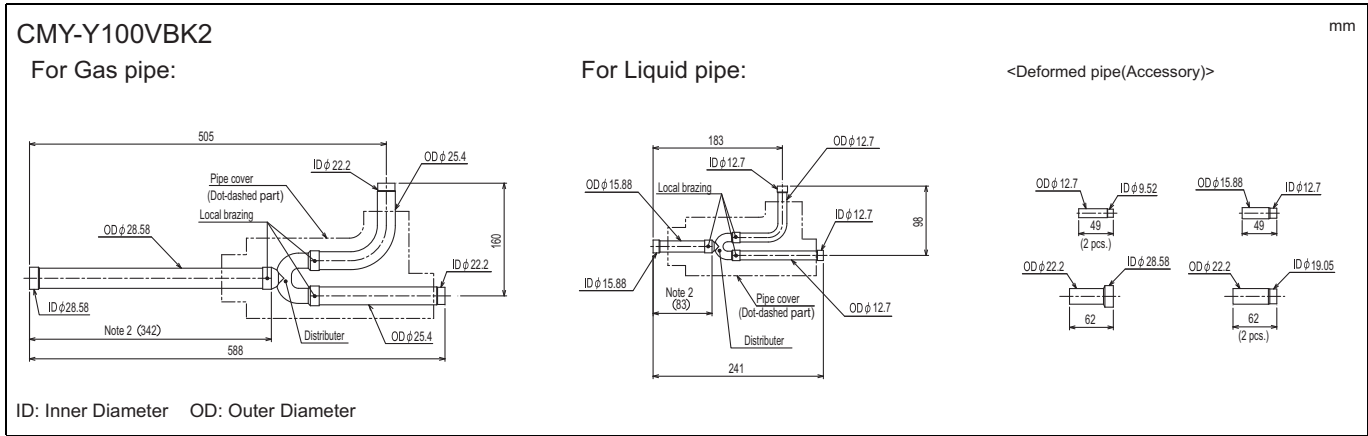

Note 1. Reference the attitude angle of the branch pipe below the fig.

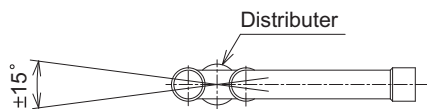

The angle of the branch pipe is within $\pm 15^\circ$ against the horizontal plane.

2. Use the attached pipe to braze the port-opening of the distributor.
3. Pipe diameter is indicated by inside diameter.